

THRESHOLDS

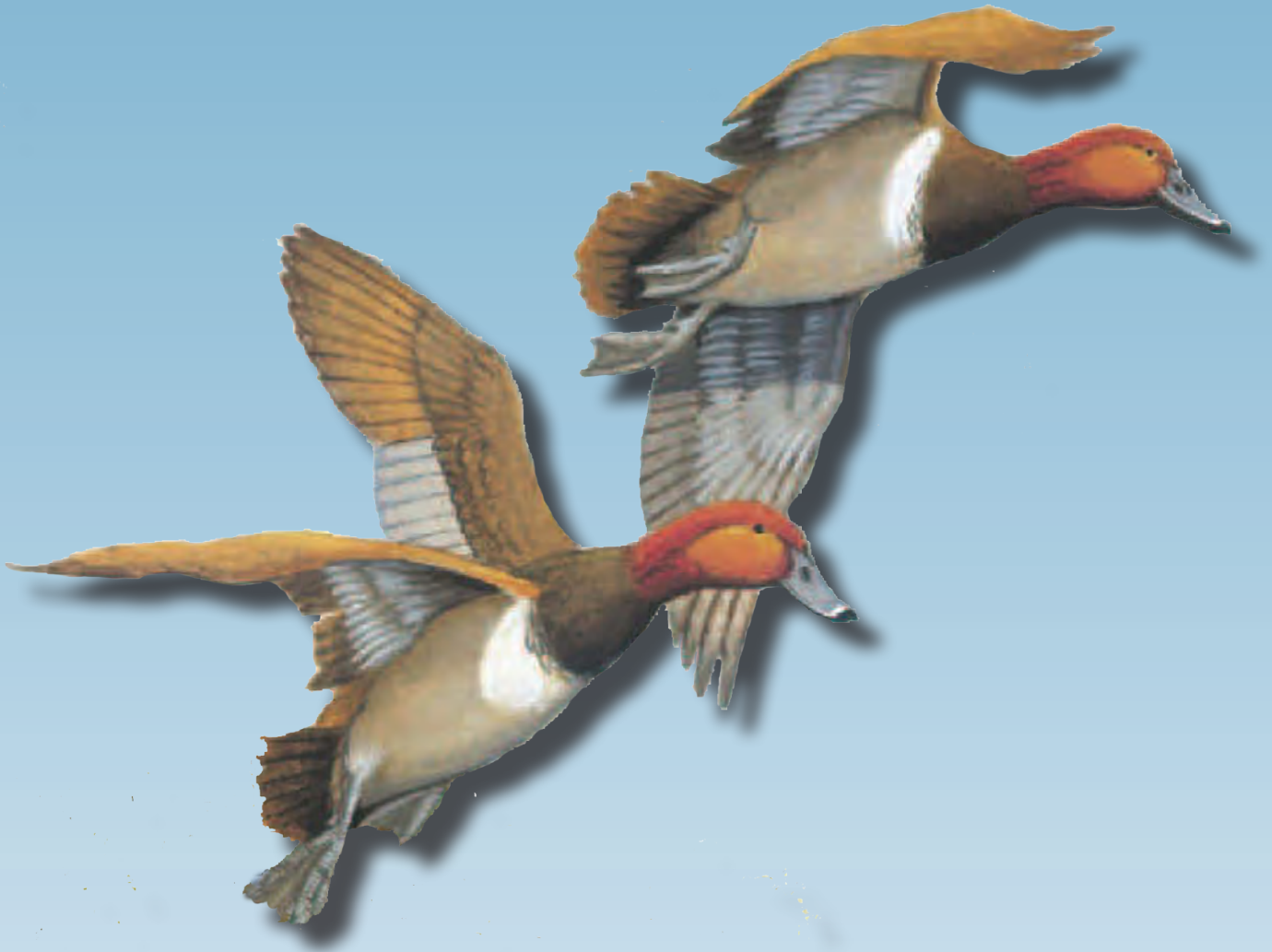

REDHEADS - Redheads are a diving duck easily recognizable by their bright red head and grey back. Redheads take new mates every year, with hens regularly laying eggs in the nests of other ducks. Not to be mistaken for similar looking canvasbacks, redheads are a magnificent species.



Threshold Product Index:

Aluminum Thresholds

	Page
Bumper Seal	T11-T13, T17, T21-T22
Carpet Dividers/ Edges	T14
Cast Aluminum	T35
Cover Plates	T32-T33
Custom Fabricated	T30-T31
Edge Components	T31
Diamond Tread Plate	T33
Elevators	T23
Floor Closer	T36, T37
Half Saddle	T16- T18
Heavy Duty	T10
Interlocking	T23
Offset	T22
Return Closed Ends	T4, T25
Ramps	T24-T29
Saddle	T6-T9, T37
Safety Tread Plates	T33
Stair Nosings	T34
Stop Strips	T11
Thermal Break	T20-T21
Transition Strip	T16

Architectural Bronze Thresholds

	Page
Bumper Seal	T41
Cover Plates	T41
Custom Fabricated	T47
Floor Closer	T36
Half Saddle	T45
Interlocking	T46
Return Closed Ends	T4
Saddle	T42-T43
Thermal Break	T44

Stainless Steel Thresholds

Bumper Seal	T40
Cover Plates	T40
Floor Closer	T36
Return Closed Ends	T4
Saddle	T38-T39

Vinyl Thresholds

Carpet/Tile Divider	T15
---------------------	-----

Fasteners

Fasteners	T40
-----------	-----

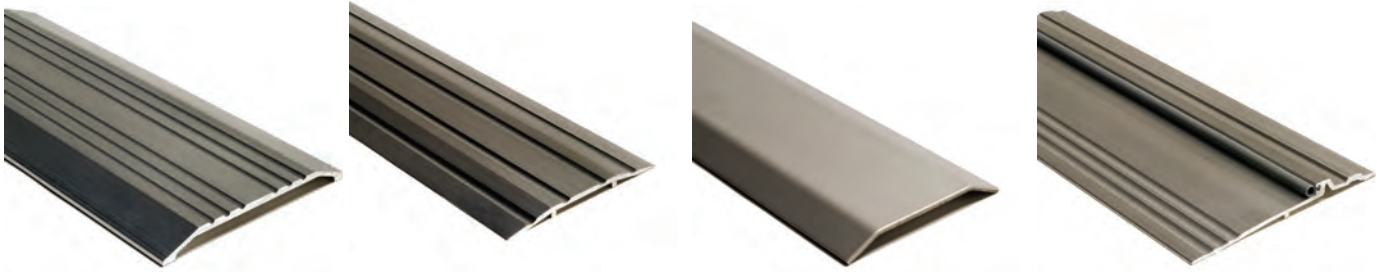

Numerical Index:

BAR1	T31	323	T17	427	T7	812SS	T39	961	T28	8152	T31
BAR1BR	T47	324	T17	427BR	T43	813	T8	962	T28	8163	T30
BAR2	T31	325	T17	427E	T6	813BR	T42	1012SS	T39	8164	T30
BAR2BR	T47	325BR	T45	427FC	T37	813FC	T37	1013	T8	8167	T30
2	T11	325HD	T10, 17	428BR	T43	813SS	T38	1013SS	T38	8168N	T30
BAR4	T31	325HDX325HD		428E	T6	814	T32	3231	T34	8170	T30
4	T11	Welded	T10A	428FC	T37	814SS	T32, 40	3241	T34	8213	T20B
BAR6SS	T32, 40	327	T18	429E	T6	818	T32	3504	T33	8413	T20A
RCE-9	T25	327BR	T45	429BR	T43	818BR	T41	3509	T34	8423	T20B
12V	T23	350	T18	430E	T6	818SS	T32, 40	3510	T33	8424	T20
RCE-15	T25	350BR	T45	430BR	T43	828	T33	3511	T34	8425	T20
RCE-21	T25	355	T18	442-5	T23	838	T32	4413	T35	8426	T20
RCE-30	T25	398	T15	442BR	T46	882	T31	4424	T35	8426BR	T44
RR42	T29	399	T15	457	T16	883SS	T40	4425	T35	8427	T20
R50	T24, 28	400	T15	458	T16	884	T13	4513	T35	8427BR	T44
RO50	T26	401	T15	473BR	T46	884B/S	T18	RR5007BL	T29	8428	T20
57	T23	402	T15	483BR	T46	884-6	T22	8013	T20A	8428BR	T44
58	T23	404	T14	484BR	T46	884-7	T22	8113	T20B	8429	T20
R75	T24	407	T15	512	T9	884-8	T22	8132	T16	8429BR	T44
RO75	T26	410	T9	512SS	T39	884SS	T40	8133	T31	8430	T20
80	T23	411	T9	513	T8	885	T22	8134	T31	8430BR	T44
80B	T46	411BR	T42	513FC	T37	885-6	T22	8135	T12	8433	T20B
R100	T24	412	T9	513BR	T42	885-7	T22	8136	T31	8434	T21
RO100	T26	412SS	T39	513HD	T10	890	T13	8136BR	T47	8435	T21
111	T9	413	T8	513SS	T38	891	T12	8137	T31	8436	T21
R125	T24	413BR	T42	515	T16	893	T12	8138	T31	8437	T21
RO125	T26	413FC	T37	525	T7	895BR	T46	8139	T31	8475	T7
R150	T24	413SS	T38	612SS	T39	896	T11	8139BR	T47	8513	T20A
RO150	T26	414	T14	613	T8	896BR	T41	8140	T31	8533	T20B
R175	T24	415	T16	613SS	T38	896HD	T10	8140BR	T47	8613	T20A
RO175	T26	415BR	T45	613BR	T42	896SS	T40	8141	T31	8633	T20B
R200	T24	416	T14	613HD	T10A	897	T12	8141BR	T47	8713	T20A
RO200	T26	417	T14	653	T14	897NS	T12	8142	T30	8813	T20A
211	T7	424	T7	654	T29	898V	T17	8142BR	T47	8913	T20A
215	T16	424BR	T43	655	T14	912SS	T39	8143	T30	Fasteners	T48
215BR	T45	424E	T6	656	T14	913	T8	8143BR	T47	RCE	T4
R225	T24	424FC	T37	657	T29	913SS	T38	8144	T30	Type 1	T36
RO225	T26	425	T7	659	T14	950	T11	8144BR	T47	Type 3	T36
R250	T24	425BR	T43	700E	T11	951	T28	8145	T30	Type 4	T36
RO250	T26	425E	T6	712SS	T39	RR952	T29	8145BR	T47	Type 5	T36
315	T16	425FC	T37	713	T8	953	T28	8146	T30		
315BR	T45	425HD	T10	713BR	T42	954	T28	8146BR	T47		
321	T18	426	T7	713FC	T37	955	T28	8147	T30		
322	T18	426BR	T43	713SS	T38	957	T28	8148	T30		
322BR	T45	426E	T6	803	T13	959	T28	8149	T30		
322X355X327	T19	426HD	T10A	804	T13	960	T28	8150	T30		

Rating Symbols Legend



ADA COMPLIANT Barrier Free Thresholds meet the requirements of ADA Standards for Accessible Design and ICC/ANSI A117.1 Accessible and Usable Buildings and Facilities.



POSITIVE PRESSURE CERTIFIED by UL to ANSI/UL10C; complies with IBC, NFPA 80 and NFPA 252 for application to Hollow Metal fire doors rated up to 3 Hrs., and Wood Fire doors rated up to 90 minutes.



CERTIFIED by UL to CAN/ULC-S104 and ANSI/UL10B; complies with NFPA 80 and NFPA 252 for application to Hollow Metal fire doors rated up to 3 Hrs., and Wood fire doors rated up to 90 minutes.



Air Infiltration Tested to ASTM E283, Standard Test Method for Determining Rate of Air Leakage Through Exterior Windows, Curtain Walls, and Doors.



SLIP-RESISTANT 'SIA' textured surface is available on all thresholds. Our process embeds and fuses bits of hot nickel and titanium into the surface of the threshold. This technology originally developed for use on aircraft carrier decks is very skid resistant and will not wear off.



ANSI/BHMA CERTIFIED. Certified thresholds comply with American National Standard for Thresholds ANSI/BHMA A156.21 and are listed in the BHMA Certified Products Directory.



Online product listings at www.ul.com/database



ANSI/BHMA

The following explains ANSI/BHMA numbers which identify material and type of products. For products that meet ANSI/BHMA Standards, look for the BHMA certified logo next to the product in our catalog. For a complete listing refer to the BHMA Certified Products Directory online at www.buildershardware.com.

ANSI/BHMA A156.21 American National Standard for Thresholds

1 Product Section	2 Material	3 Configuration	4 Surface	5 Description	6 Description
"J" designates Architectural Door Trim, Thresholds	1. Architectural Brass or Bronze 3. Aluminum 5. Stainless Steel 7. Rubber & similar non-metals 0. Other	1. Compressing Top 2. Flat Saddle 3. Half Saddle 4. Interlocking 5. Rabbeted, latching/ Panic 6. Rabbeted, latching/ Panic w/gasket 7. Plate 8. Ramped 9. Saddle for floor closer. 0. None designated	1. Fluted 2. Fluted w/slip-resistant finish 3. Smooth 4. Smooth w/ slip resistant finish	1. Applied Stop 2. Applied Stop w/ gasket 3. Barrier Free 4. Carpet Separator 5. Ends Mitered 6. Expansion Assembly 7. Hook Strip Applied to door 8. Offset 9. Thermal Barrier 0. None Designated	1. Applied Stop 2. Applied Stop w/ gasket 3. Barrier Free 4. Carpet Separator 5. Ends Mitered 6. Expansion Assembly 7. Hook Strip Applied to door 8. Offset 9. Thermal Barrier 0. None Designated Suffix- HD = Heavy Duty

Materials

Thresholds are Aluminum Alloy 6063, T5 temper, unless noted.
 Cover Plates 818, 814 and 828 are Aluminum Alloy 3003, H14 hardness.
 Cover Plate 838 is Aluminum Alloy 5052, H32 hardness.

Architectural Bronze Thresholds are Alloy CDA 385 (Copper Alloy No. C38500), Architectural Bronze.
 Brass Cover Plate 818BR is Alloy CDA 260 (Copper Alloy No. C26000) cold formed Cartridge Brass.

Stainless Steel Thresholds and Cover Plates are Type 304; known for its excellent corrosion resistance, high tensile strength and resistance to oxidation.

Threshold Finishes

				NGP Suffix:
Aluminum:	Mill Finish	ANSI/BHMA 719	US27	None
	Dark Bronze			DKB
	Polished	ANSI/BHMA 717		POL
	Powder Coated Colors – Slip Resistant	See Page L2 for details		SIA
Architectural Bronze:	Satin Finish	ANSI/BHMA 728	US4	BR
	Dark Bronze Oil Rubbed	ANSI/BHMA 722	US10B	BR-DKB
	Polished	ANSI/BHMA 721	US3	BR-POL
	Slip Resistant			BR-SIA
Stainless Steel:	Mill Finish			SS
	Brushed (#4)	ANSI/BHMA 630	US32D	SS-Brushed
	Polished	ANSI/BHMA 629	US32	SS-POL
	Slip Resistant			SS-SIA

Slip Resistant Finish

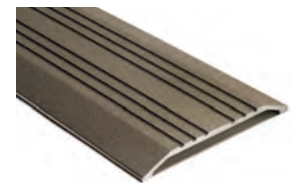

SIA (Slick It Ain't) finish is our slip resistant textured surface, available on all thresholds up to 24" wide and on 818 aluminum and brass cover plates up to 10" wide.

Our SIA technology embeds bits of hot nickel and titanium into the surface of the threshold using a high pressure thermo-electrostatic process. It was originally developed for use on aircraft carrier decks. SIA finish is very durable and will not wear off.

This results in a slip resistant surface that is similar to high grit sandpaper.

Aluminum and Stainless Steel SIA finish thresholds are a pewter color.
 Architectural Bronze SIA finish thresholds are a brass color.

Powder Coat Finish

Powder Coat finish is available on most thresholds upon request. Refer to page L2 for standard color options. Consult factory for custom color matching.

General Information

Thresholds are furnished longer than ordered to allow for field sizing and fitting. 1/2" is added to thresholds under 61"; 1" is added to thresholds over 61". Unless noted, thresholds are punched for and provided with fasteners. Special Drilling and Notching is available; details must be provided with the order. Radiation shielding with .030" thick Lead is available on most thresholds. Specify "Lead Lined". Catalog Illustrations are full scale, except as noted.

Returned Closed Ends

Return Closed Ends (RCE's) are available on most beveled thresholds. The corner is miter cut on a 45 degree angle and returned to the face of the door frame for a neat, clean, finished appearance. Specify: "RCE"

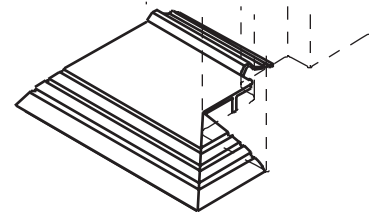

Custom Fabricated Thresholds

Our Custom Fab dept. specializes in producing custom made-to order thresholds to your specifications. Submit your details to our technical dept. for a quotation and drawing for your approval. Components shown on pages T-30, T-31 and T-47 are used to build special assemblies like the one illustrated below. Aluminum, Brass and Stainless Steel Cover Plates are also custom formed and welded to meet special requirements.

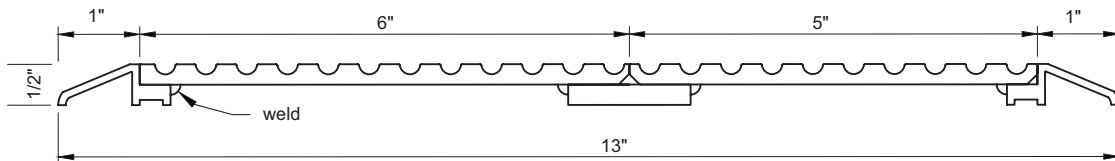

8137 x 8146 (Rip to 6") x 8145 x 8137 x Bar4 x Welded profile Assembly View

Sports Floor Threshold Assemblies

Wood gymnasium sports floors are designed to be free floating. We offer threshold assemblies to cover the transition from the primary floor to the sports floor. As the sports floor shifts, the threshold assembly will allow expansion and contraction by the top plate moving with the sports floor.

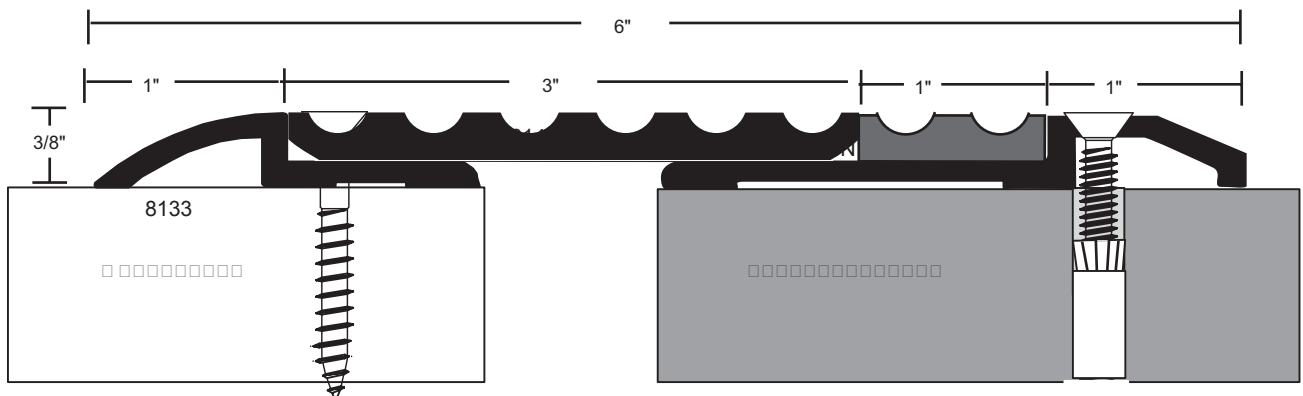

8133 x 8143 x 8168N (Neoprene) x 8139 x 10-24 MS/LA

Also available in 1/2" high and in other widths - contact NGP Technical Department

LEED Green Building

The LEED (Leadership in Energy and Environmental Design) Green Building Rating System® is a national standard for developing high-performance, sustainable buildings developed by the U. S. Green Building Council.

Based on recent historical records and forecast, raw materials utilized in and contained in NGP products average the following percentages of recycled materials:

	Post Consumer Recycled %	Pre-Consumer Recycled %
Aluminum Thresholds	18%	49%
Architectural Bronze Thresholds	70%	25%
Stainless Steel Thresholds	25%	3%
Rubber Ramps	0%	0%
Gasketing with Aluminum Retainers	13%	37%
Gasketing with Bronze Retainers	52%	19%
Gasketing with Stainless Steel Retainers	19%	2%
Self-Adhesive Gasketing	0%	0%
Finger Guard 2248	13%	37%
Finger Guard 2252	0%	0%
Metal Edge/Astragal sets (Steel)	25%	3%
Lite Kits & Louvers (Steel)	15%	5%
Aluminum Louvers	18%	49%

Our current LEED letter containing LEED qualification information for all our products is available at www.ngp.com

Environmental Product Declarations (EPD) prepared and certified by an Independent Laboratory based on Life Cycle Assessments (LCA) of our products may be viewed on our website www.ngp.com

Health Product Declarations (HPD) may be viewed on our website www.ngp.com

National Guard Products sustainability report may be viewed on our website www.ngp.com

Contact us regarding our end of use product recycling program.

Buy American Requirements

Buy American Act

Over 99% of our products are produced in the United States as a domestic construction material, as defined in the Buy American Act (BAA) of March 1933 and amended by the Buy American Act of 1988 and FAR 52.225-9. A Buy American certificate may be obtained on our website www.ngp.com

Federal American Recovery and Reinvestment Act

More than 99% of our products qualify as manufactured products produced in the United States as manufactured goods, as defined in OMB Guidance (176.140; 176.70(a) (2) (ii); 176.160, complying with the Federal American Recovery Reinvestment Act, ARRA-2009. Contact us for a Buy America ARRA certificate for your project.

Buy America

More than 99% of our products comply with Buy America Requirements of 49 U.S.C. 5323(j)(1), and the applicable regulations in 49 CFR part 661. Contact us for a Certificate of Compliance for your project.

Components of unknown origin are considered to have been produced or manufactured outside the United States.

Saddle Thresholds

All thresholds this page

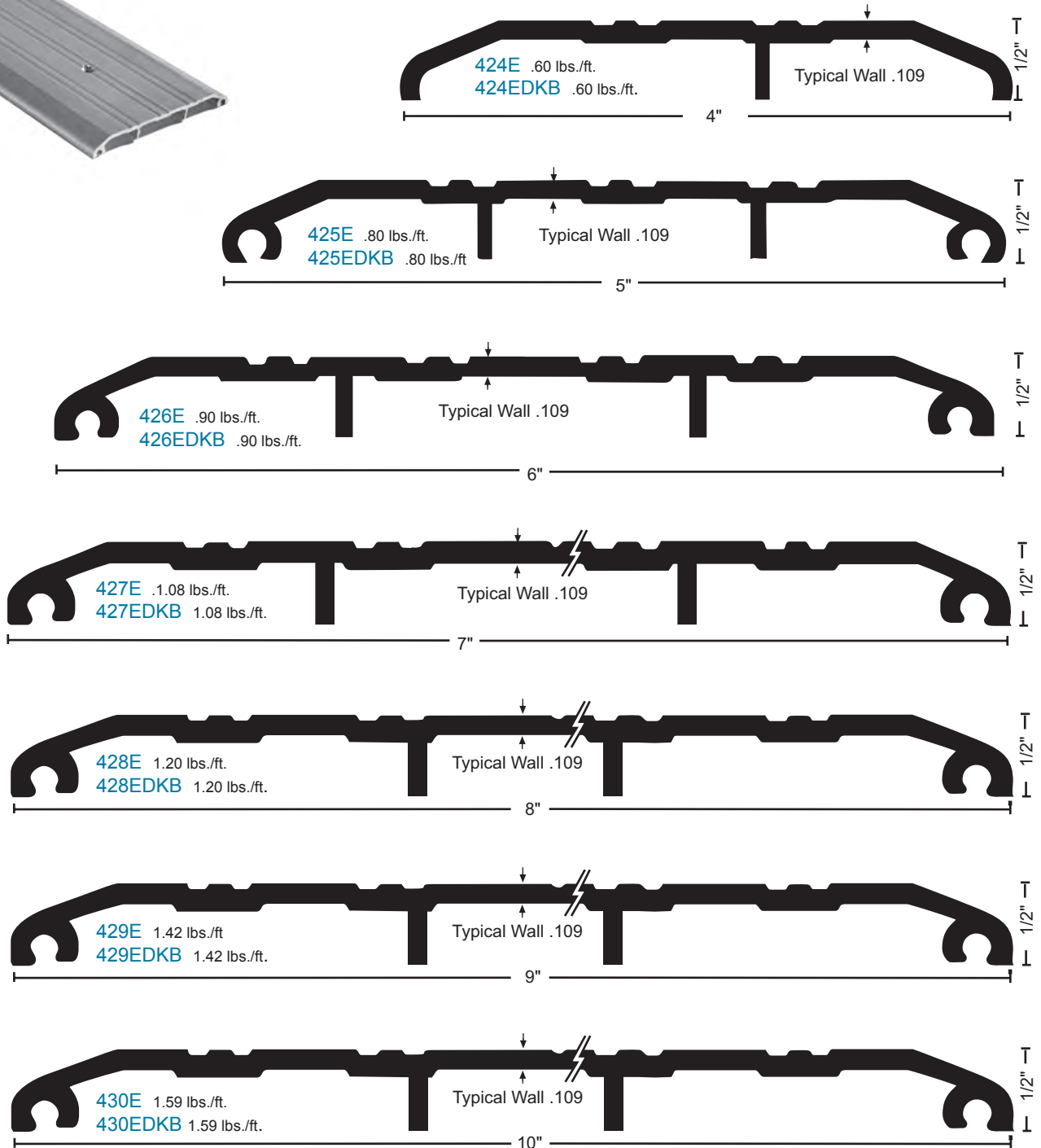

MATERIALS & FINISHES

- Aluminum mill finish
- DKB - Aluminum dark bronze finish



• Optional: Slip Resistant SIA Finish

FASTENERS



#10 x 1-1/2" FH zinc plated wood screws furnished. Dark bronze supplied with DKB thresholds.



VINYL FOOT SEAL OPTION:

used instead of caulking to increase the weather resistance of the threshold. Specify on order.

Saddle Thresholds

All thresholds this page  

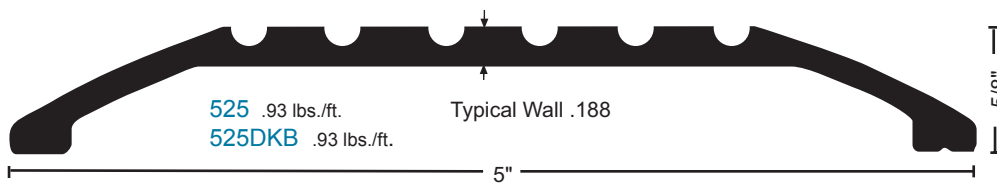
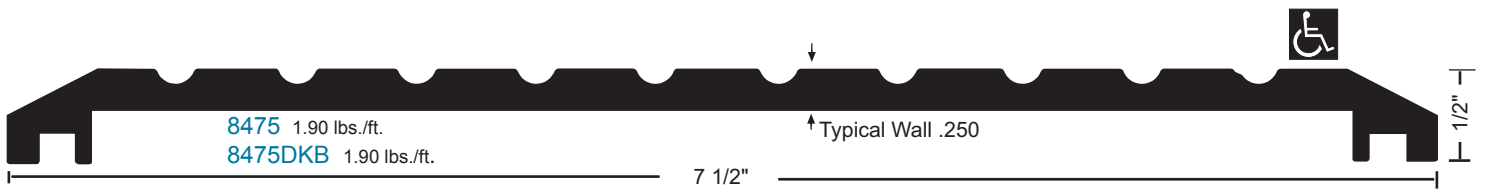
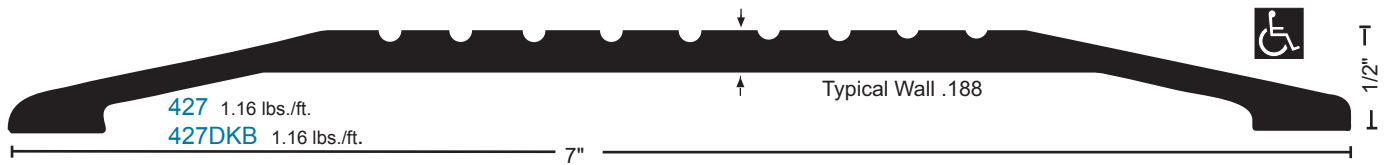
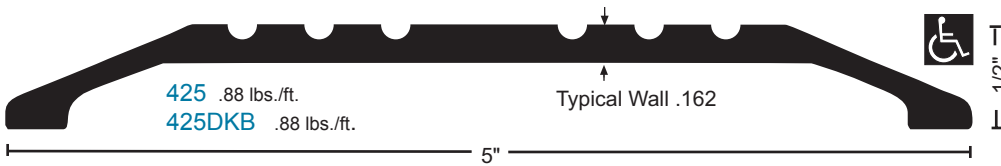
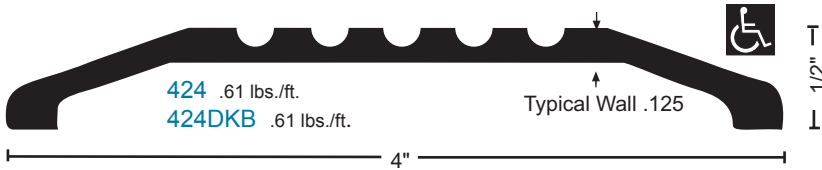
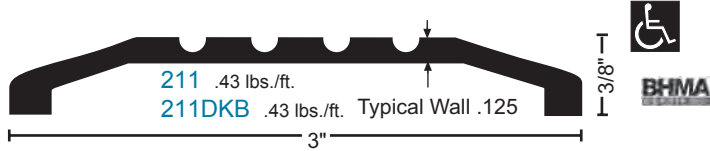
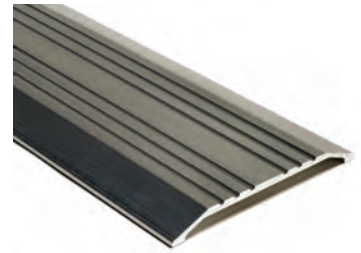

MATERIALS & FINISHES

- Aluminum mill finish
- DKB - Aluminum dark bronze finish



• Optional: Slip Resistant SIA Finish

FASTENERS

#10 x 1-1/2" FH zinc plated wood screws furnished. Dark bronze supplied with DKB thresholds.

Saddle Thresholds

All thresholds this page

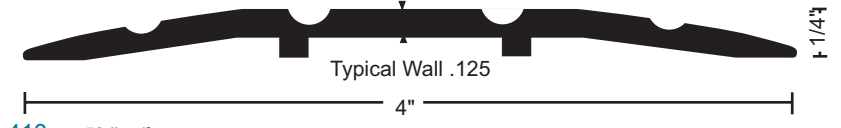
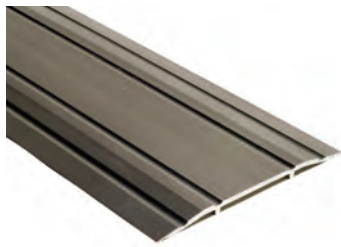

413 .53 lbs./ft.
413DKB .53 lbs./ft.

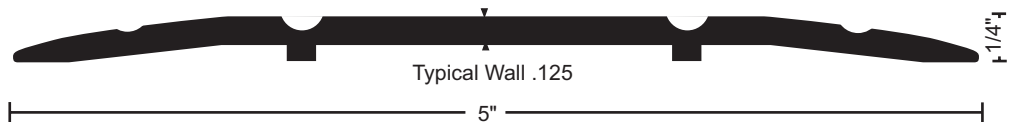

513 .68 lbs./ft.
513DKB .68 lbs./ft.

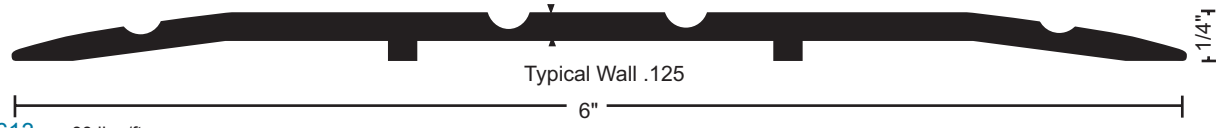

613 .88 lbs./ft.
613DKB .88 lbs./ft.

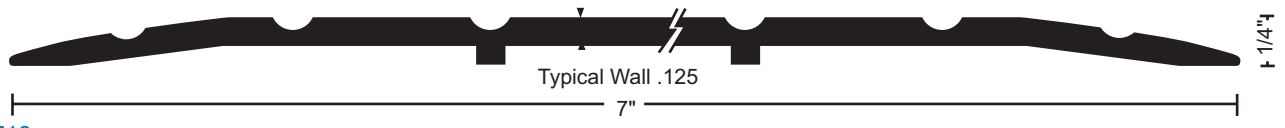

713 1.01 lbs./ft.
713DKB 1.01 lbs./ft.

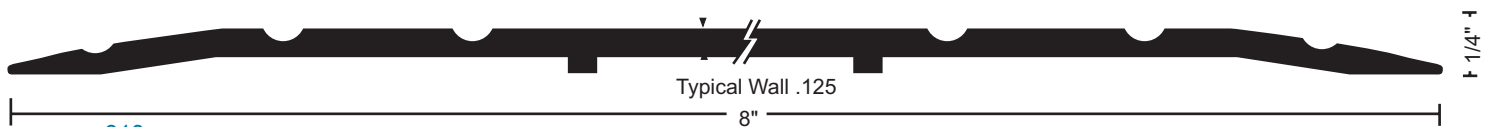

813 1.20 lbs./ft.
813DKB 1.20 lbs./ft.

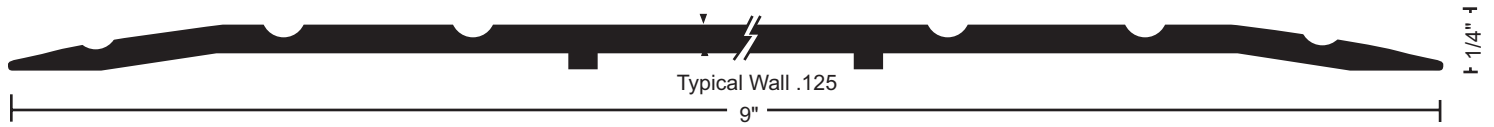

913 1.41 lbs./ft.
913DKB 1.41 lbs./ft.

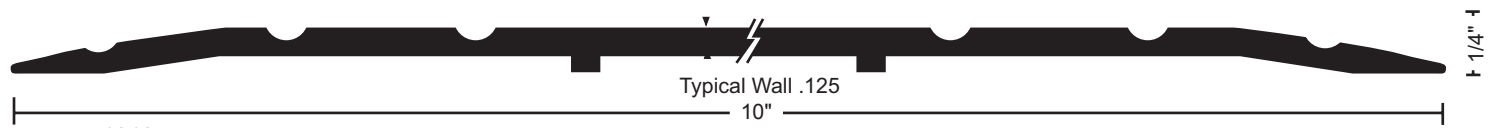

1013 1.63 lbs./ft.
1013DKB 1.63 lbs./ft.

MATERIALS & FINISHES

- Aluminum mill finish
- DKB - Aluminum dark bronze finish



• Optional: Slip Resistant SIA Finish

FASTENERS

#10 x 1-1/2" FH zinc plated wood screws furnished. Dark bronze supplied with DKB thresholds.

Smooth Surface Thresholds

Recommended to provide the best results where automatic door bottoms are used.

All thresholds this page    

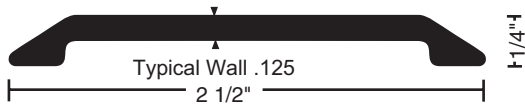

410 .36 lbs./ft.
410DKB .36 lbs./ft.

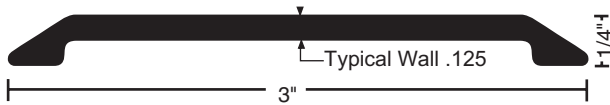

411 .50 lbs./ft.
411DKB .50 lbs./ft.

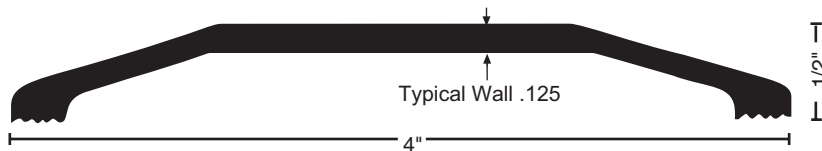

412 .63 lbs./ft.
412DKB .63 lbs./ft.

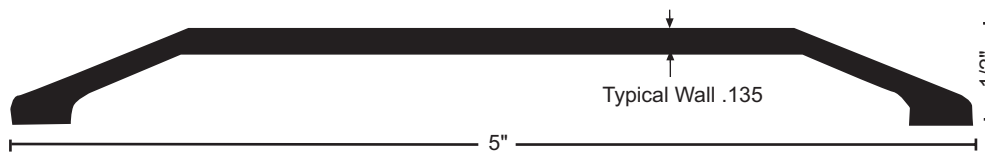

512 .82 lbs./ft.
512DKB .82 lbs./ft.

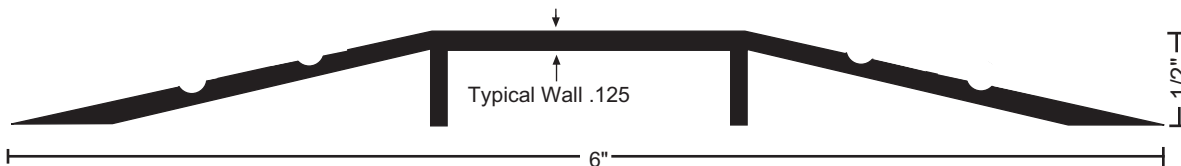

111 .93 lbs./ft.
111DKB .93 lbs./ft.

MATERIALS & FINISHES

- Aluminum mill finish
- DKB - Aluminum dark bronze finish



- Optional: Slip Resistant SIA Finish

FASTENERS

#10 x 1-1/2" FH zinc plated wood screws furnished. Dark bronze supplied with DKB thresholds.

Heavy Duty Thresholds

All thresholds this page



- For use where forklift or vehicular traffic occurs.
- Recommended for delivery/storage doorways where heavier loads travel.
- BHMA certified to ANSI A156.21 Heavy Duty 10,000 lb. load test.
- Optional "SIA" slip-resistant finish recommended in moisture prone areas.

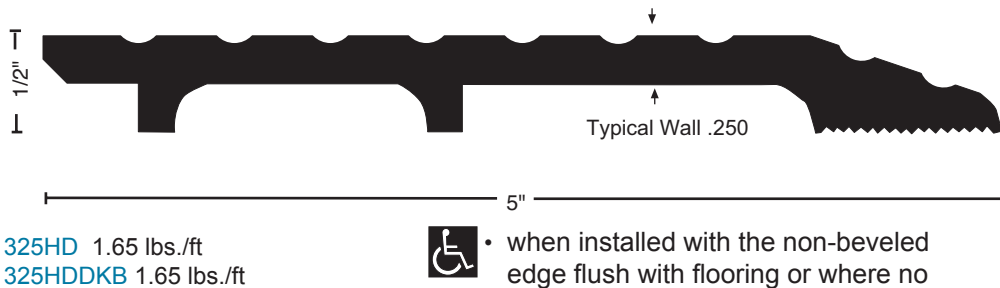
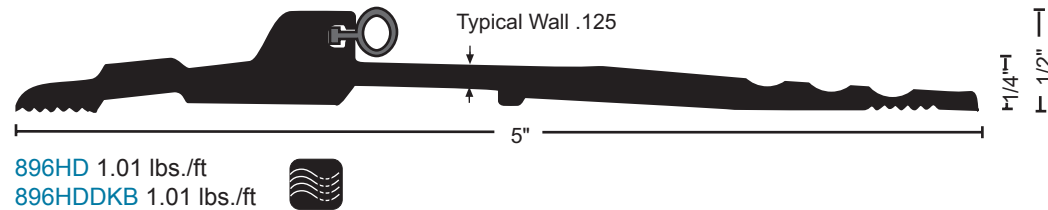
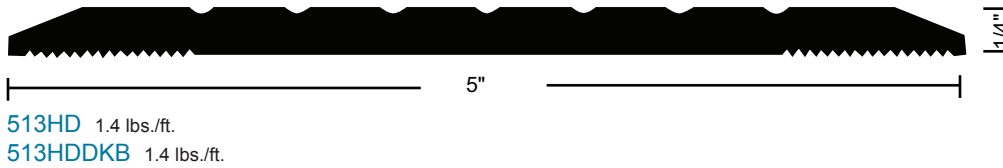
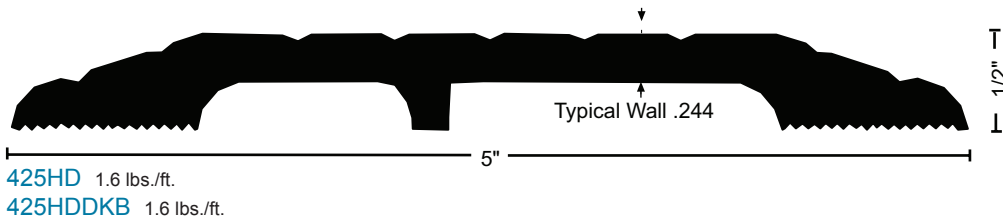

• when installed with the non-beveled edge flush with flooring or where no greater than 1/4" vertical rise occurs



BUMPER SEAL
Seals against the door providing weather resistance

Vinyl ("V") supplied unless other material specified

Options:
NGP-TPV ("N")
Silicone ("S")

MATERIALS & FINISHES

- Aluminum mill finish
- DKB - Aluminum dark bronze finish



• Optional: Slip Resistant SIA Finish

FASTENERS

#10 x 1-1/2" FH zinc plated wood screws furnished. Dark bronze supplied with DKB thresholds.

Heavy Duty Thresholds

All thresholds this page    



- For use where forklift or vehicular traffic occurs.
- Recommended for delivery/storage doorways where heavier loads travel.
- Optional "SIA" slip-resistant finish recommended in moisture prone areas.

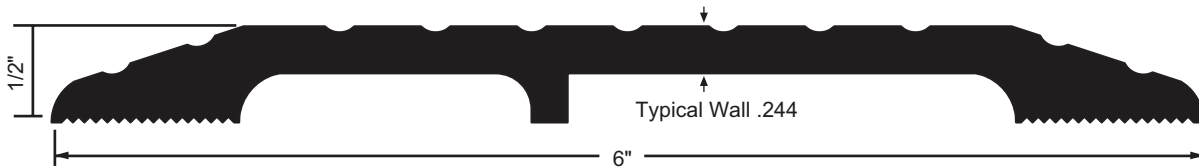

426HD 1.98 lbs./ft.
426HDDKB 1.98 lbs./ft.

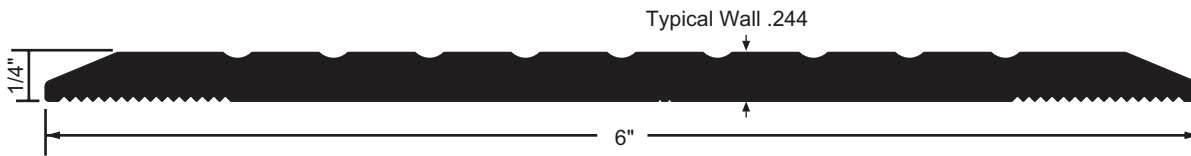

613HD 1.66 lbs./ft.
613HDDKB 1.66 lbs./ft. BHMA certified to ANSI A156.21 Heavy Duty 10,000 lb. load test.

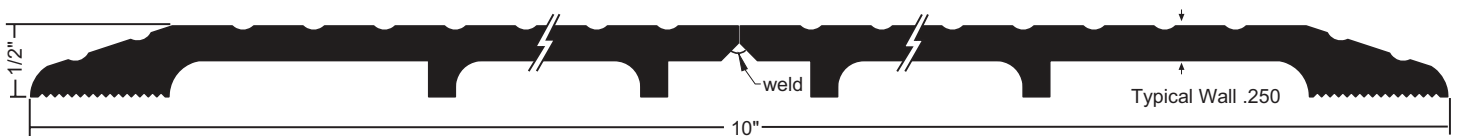

325HD x 325HD Welded 3.33 lbs./ft.
325HDDKB x 325HDDKB Welded 3.33 lbs./ft. BHMA certified to ANSI A156.21 Heavy Duty 10,000 lb. load test.

MATERIALS & FINISHES

- Aluminum mill finish
- DKB - Aluminum dark bronze finish



• Optional: Slip Resistant SIA Finish

FASTENERS

#10 x 1-1/2" FH zinc plated wood screws furnished. Dark bronze supplied with DKB thresholds.



Page
Intentionally
Blank

ADA Compliant Bumper Seal Thresholds

All thresholds this section

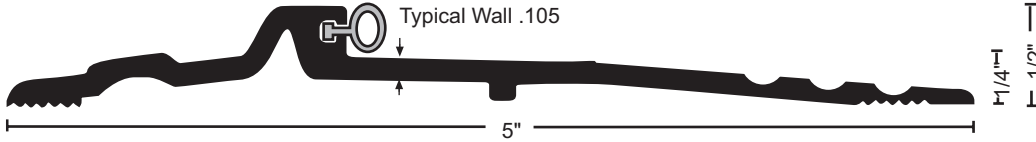
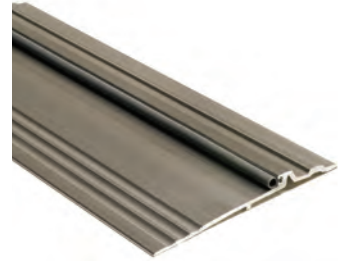

896 .64 lbs./ft.
896DKB .64 lbs./ft. **BHMA**

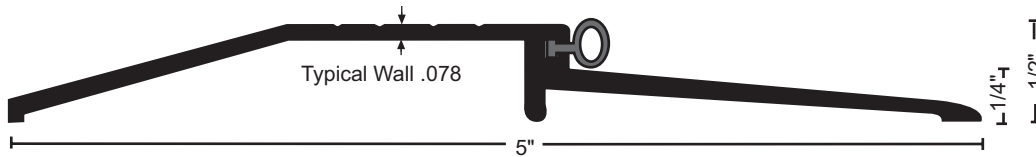

950 .50 lbs./ft.
950DKB .50 lbs./ft. **BHMA**
Excellent for use with Automatic Door Bottoms



BUMPER SEAL
Seals against the door providing weather resistance

Vinyl ("V") supplied unless other material specified

Options:
NGP-TPV ("N")
Silicone ("S")

Stop Strips

All stop strips this section

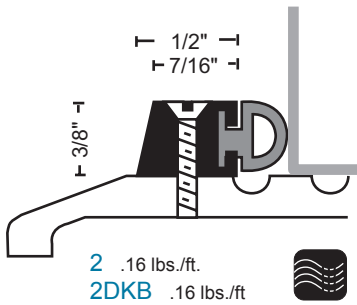

2 .16 lbs./ft.
2DKB .16 lbs./ft. **BHMA**

#6 self-tapping machine screw provided

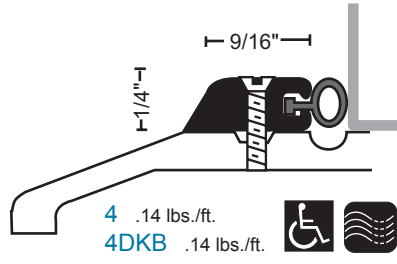

4 .14 lbs./ft.
4DKB .14 lbs./ft. **BHMA**

#6 self-tapping machine screw provided

MATERIALS & FINISHES

- Aluminum mill finish
- DKB - Aluminum dark bronze finish



• Optional: Slip Resistant SIA Finish

FASTENERS

#10 x 1-1/2" FH zinc plated wood screws furnished. Dark bronze supplied with DKB thresholds.

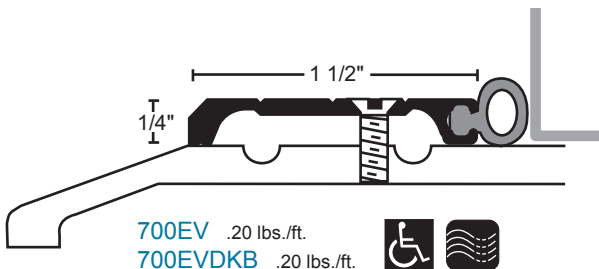

700EV .20 lbs./ft.
700EVDKB .20 lbs./ft. **BHMA**

#10 self-tapping machine screw provided

Bumper Seal Thresholds

All products this page   

8135 .60 lbs./ft.
8135DKB .60 lbs./ft.

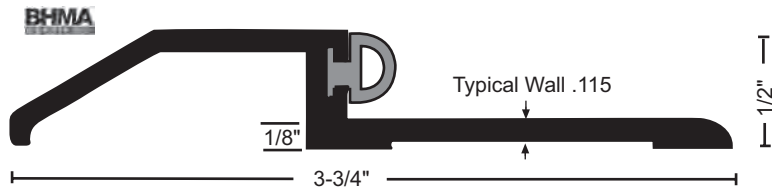

893 .86 lbs./ft.
893DKB .86 lbs./ft.

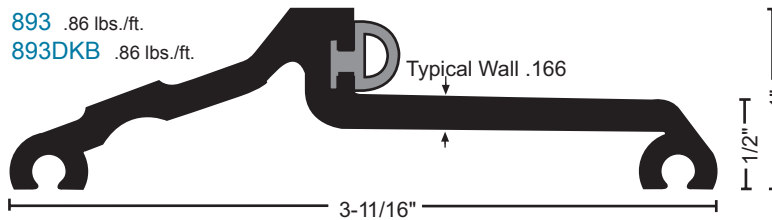

897 .91 lbs./ft.
897DKB .91 lbs./ft.

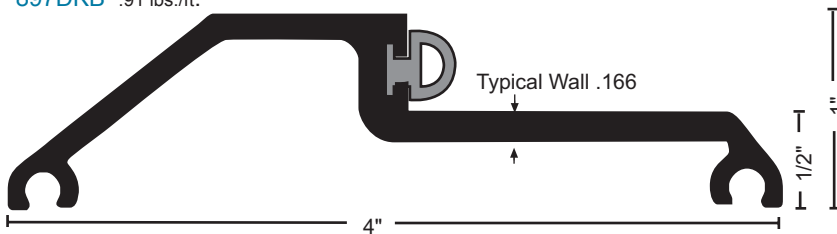

897NS .91 lbs./ft.
897NSDKB .91 lbs./ft.
Acoustical tested with neoprene seal added
See page G4

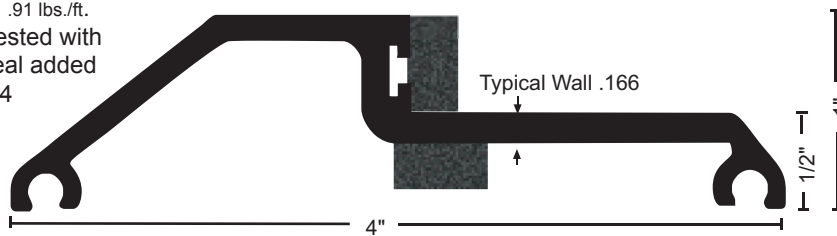

891 .62 lbs./ft.
891DKB .62 lbs./ft.

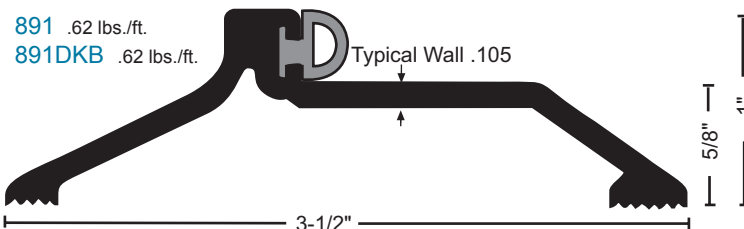

BUMPER SEAL
Seals against the door providing weather resistance

Vinyl ("V") supplied unless other material specified

Options:
NGP-TPV ("N")
Silicone ("S")
Pile ("P")

MATERIALS & FINISHES

- Aluminum mill finish
- DKB - Aluminum dark bronze finish



• Optional: Slip Resistant SIA Finish

FASTENERS

#10 x 1-1/2" FH zinc plated wood screws furnished. Dark bronze supplied with DKB thresholds.



VINYL FOOT SEAL OPTION:
used instead of caulking to increase the weather resistance of the threshold. Specify on order.

Bumper Seal Thresholds

All thresholds this page    

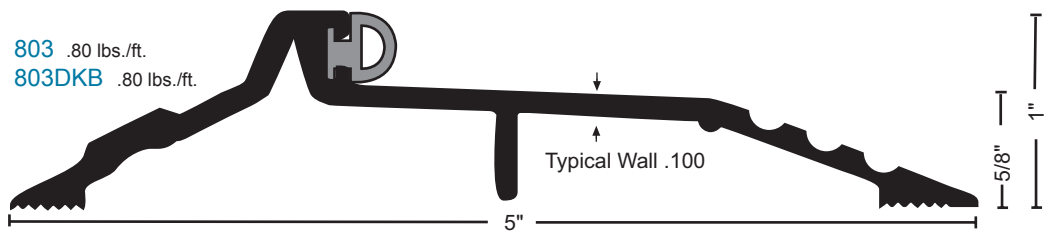
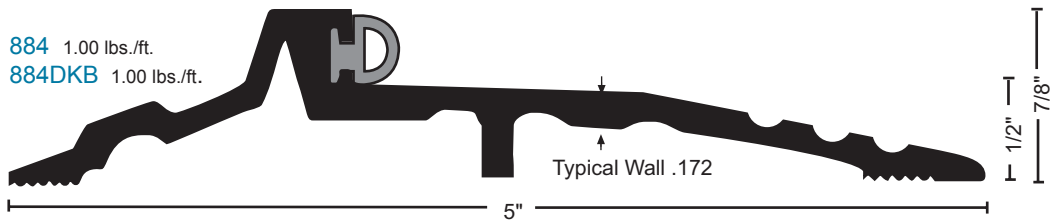
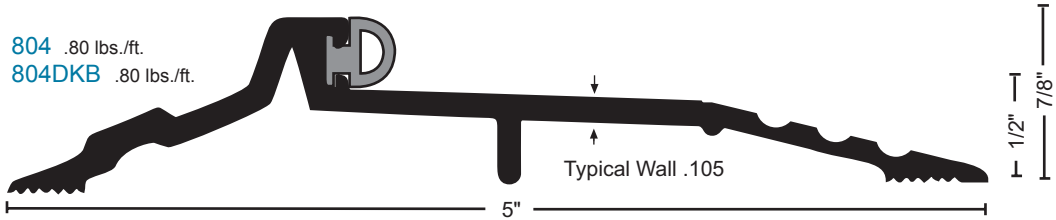
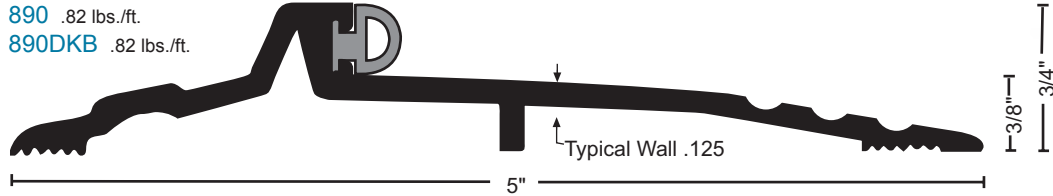

BUMPER SEAL
Seals against the door providing weather resistance

Vinyl ("V") supplied unless other material specified

Options:
NGP-TPV ("N")
Silicone ("S")
Pile ("P")

MATERIALS & FINISHES

- Aluminum mill finish
- DKB - Aluminum dark bronze finish



• Optional: Slip Resistant SIA Finish

FASTENERS

#10 x 1-1/2" FH zinc plated wood screws furnished. Dark bronze supplied with DKB thresholds.

Offset Thresholds

All thresholds this page

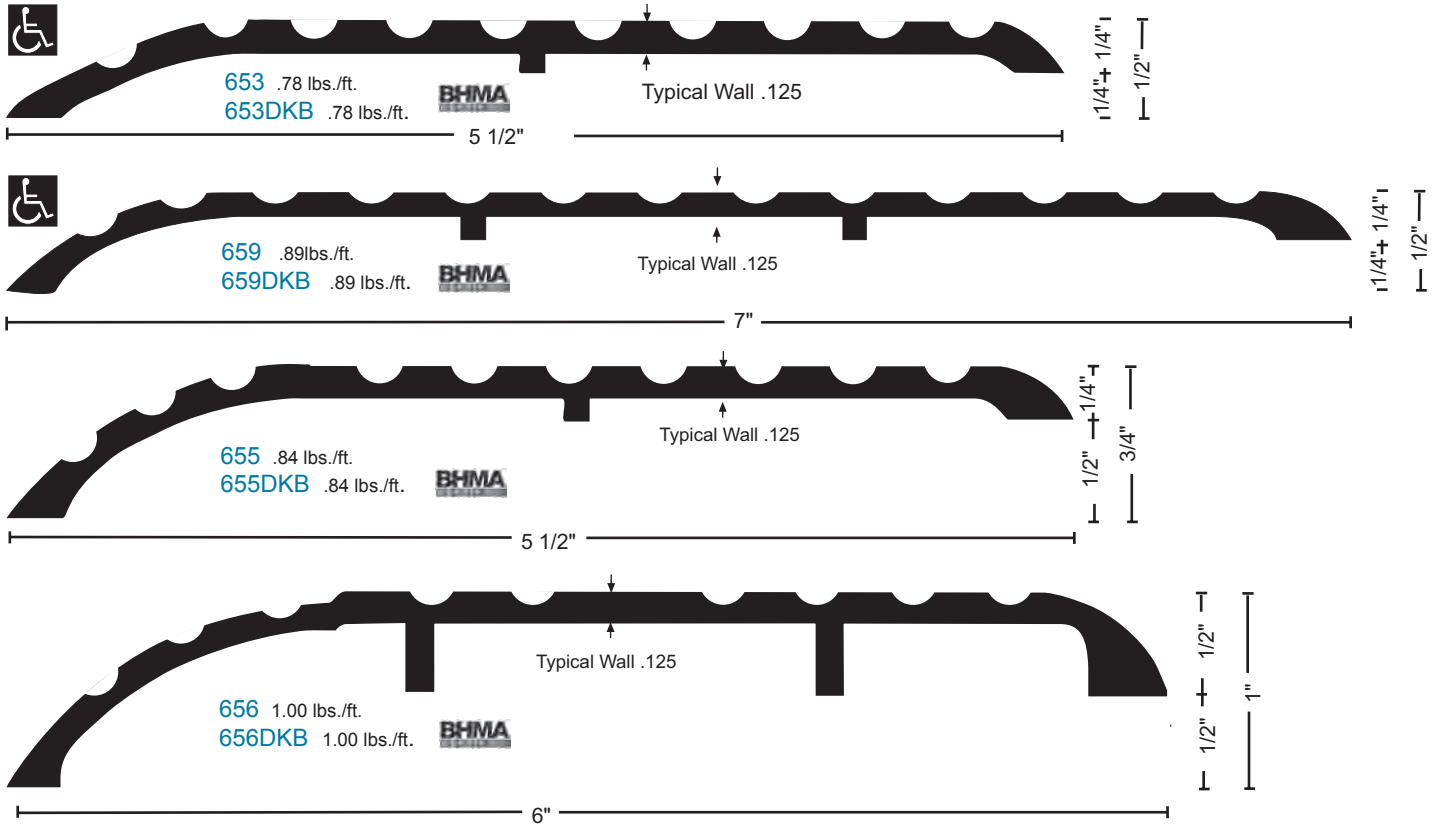

Carpet and Tile Dividers

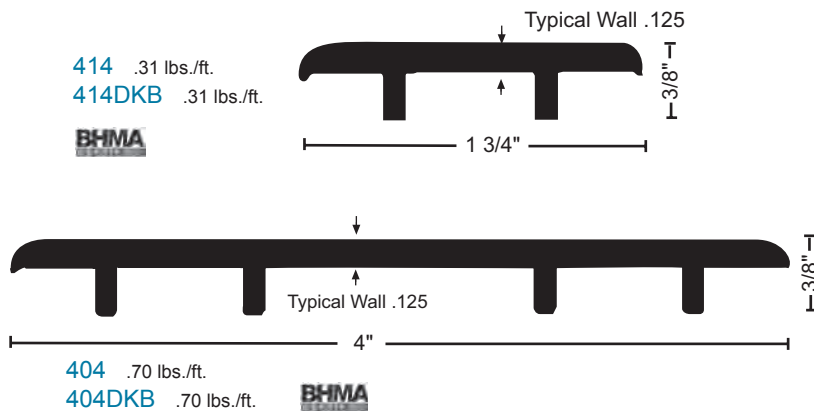

Carpet Edges

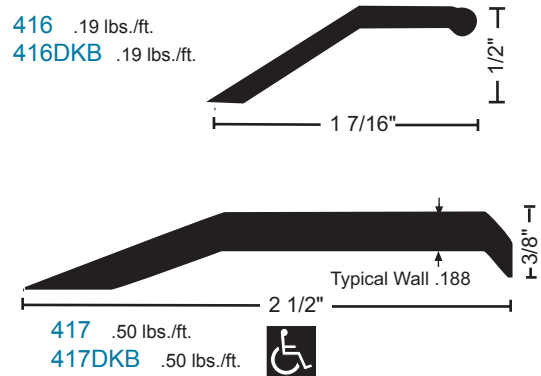

MATERIALS & FINISHES

- Aluminum mill finish
- DKB - Aluminum dark bronze finish



- Optional: Slip Resistant SIA Finish

FASTENERS

#10 x 1-1/2" FH zinc plated wood screws furnished. Dark bronze supplied with DKB thresholds.

Vinyl Carpet/Tile Divider Thresholds

For transition between two different carpets or carpet to tile.
 Easy to install using adhesive like NGP RR5007BL, Black RTV silicone rubber construction sealant. Each tube bonds 4' of 398 or 399, 8' of 400 or 401, 12' of 402, or 15' of 407.

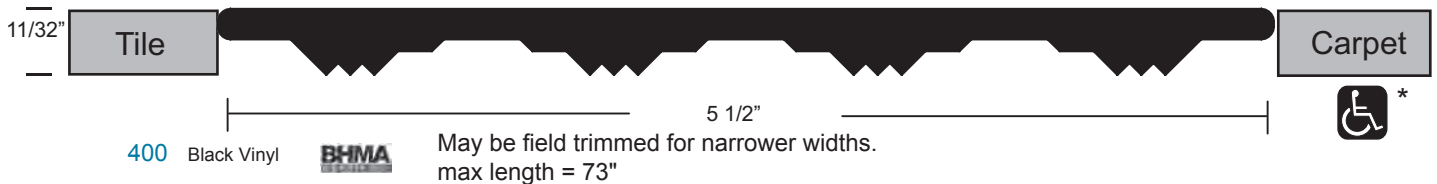
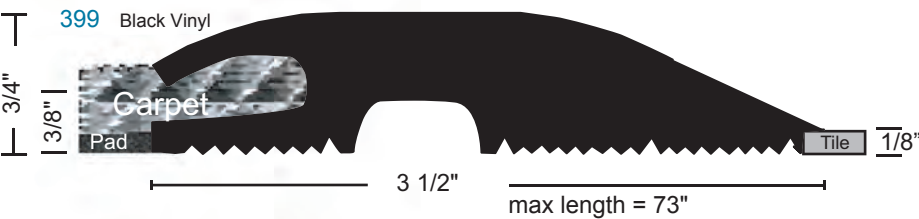
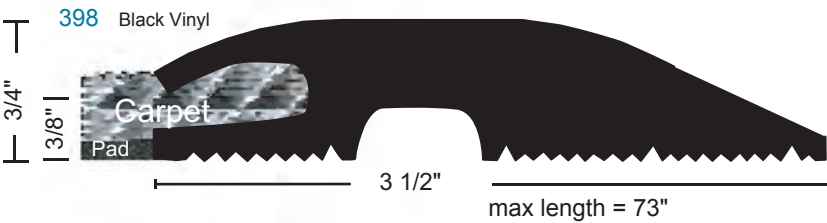
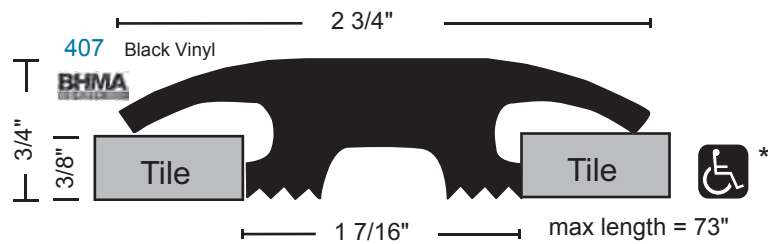
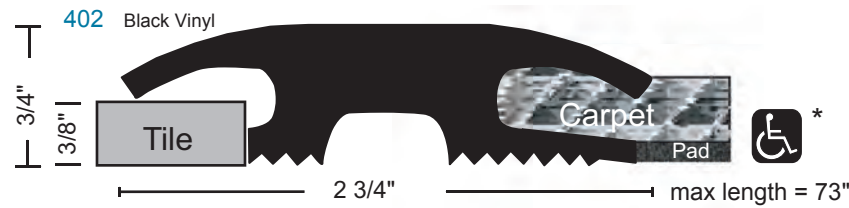
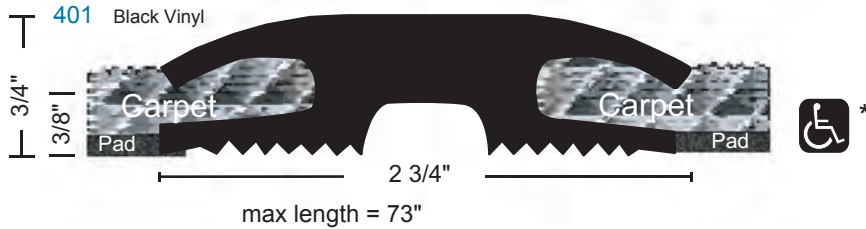

All products this page



* when installed as illustrated between carpet and/or tile

Transition Strip

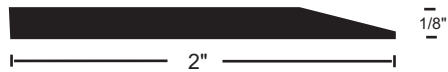

8132 .28 lbs./ft.
8132DKB .28 lbs./ft.



- Heavy Duty - for transition at edge of 1/8" vinyl tile.
- Protects edge of tile.
- Reduces tripping hazard.
- Available in 96" length only.
- #14 stainless steel SMS furnished.

All Products this page



MATERIALS & FINISHES

- Aluminum mill finish
- DKB - Aluminum dark bronze finish



- Optional: Slip Resistant SIA Finish

FASTENERS

#10 x 1-1/2" FH zinc plated wood screws furnished. Dark bronze supplied with DKB thresholds.

Half Saddle and Extended Width Components

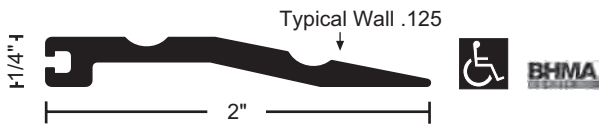

215 .28 lbs./ft.
215DKB .28 lbs./ft.

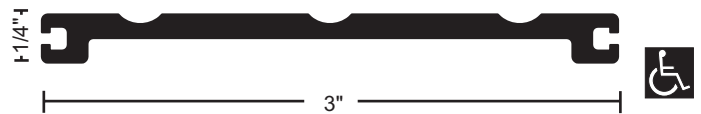

515 .45 lbs./ft.
515DKB .45 lbs./ft.

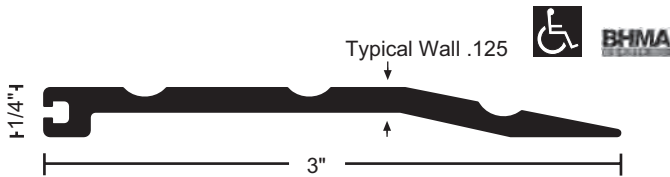

315 .41 lbs./ft.
315DKB .41 lbs./ft.

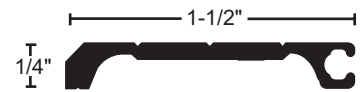

700E .20 lbs./ft.
700EDKB .20 lbs./ft.

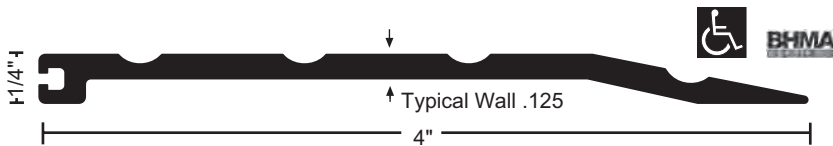

415 .55 lbs./ft.
415DKB .55 lbs./ft.

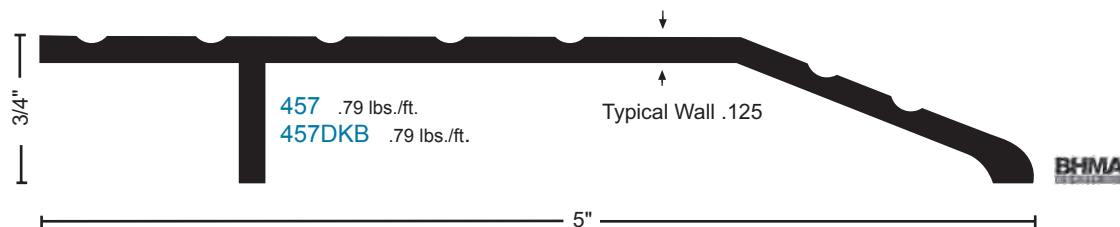

457 .79 lbs./ft.
457DKB .79 lbs./ft.



458 1.11 lbs./ft.
458DKB 1.11 lbs./ft.



Half Saddle Thresholds

All Products this page



*



* when installed with the non-beveled edge flush with flooring, or where no greater than 1/4" vertical rise occurs.

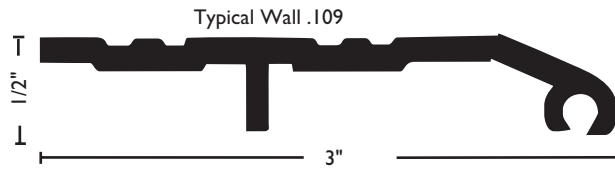

323 .56 lbs./ft.
323DKB .56 lbs./ft.



VINYL FOOT SEAL OPTION:
 used instead of caulking to increase the weather resistance of the threshold. Specify on order.



BUMPER SEAL

Seals against the door providing weather resistance

Vinyl ("V") supplied unless other material specified

Options:

NGP-TPV ("N")
 Silicone ("S")

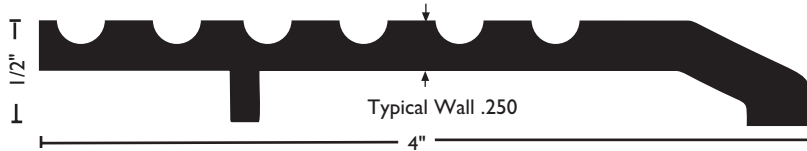

324 1.20 lbs./ft.
324DKB 1.20 lbs./ft.

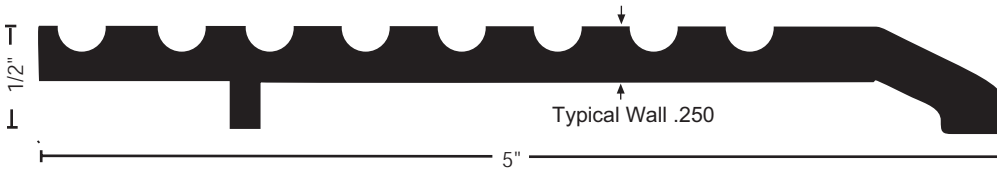

325 1.32 lbs./ft.
325DKB 1.32 lbs./ft.

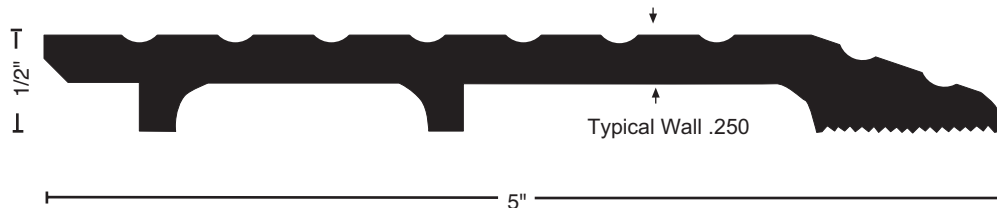

325HD 1.65 lbs./ft
325HDDKB 1.65 lbs./ft

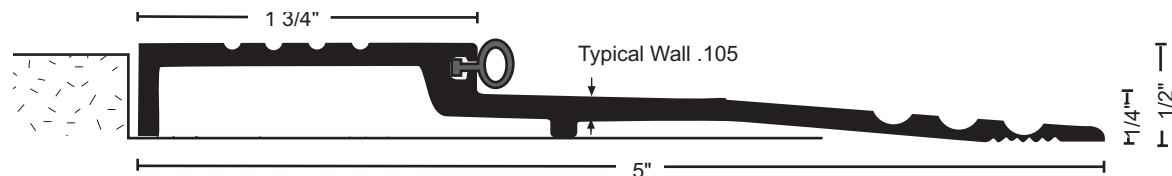

898 .72 lb/ft
898DKB .72 lb/ft



MATERIALS & FINISHES

- Aluminum mill finish
- DKB - Aluminum dark bronze finish



• Optional: Slip Resistant SIA Finish

FASTENERS

#10 x 1-1/2" FH zinc plated wood screws furnished. Dark bronze supplied with DKB thresholds.





NATIONAL GUARD PRODUCTS, INC.

Phone 800-647-7874
 Fax 800-255-7874

orders@ngp.com
 quotes@ngp.com

www.ngp.com

Half Saddle Thresholds and Extended Width Components

All thresholds this page  

MATERIALS & FINISHES

- Aluminum mill finish
- DKB - Aluminum dark bronze finish



- Optional: Slip Resistant SIA Finish

FASTENERS

#10 x 1-1/2" FH zinc plated wood screws furnished. Dark bronze supplied with DKB thresholds.

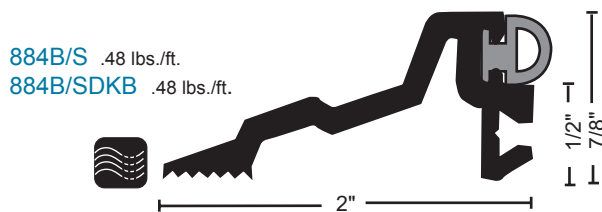
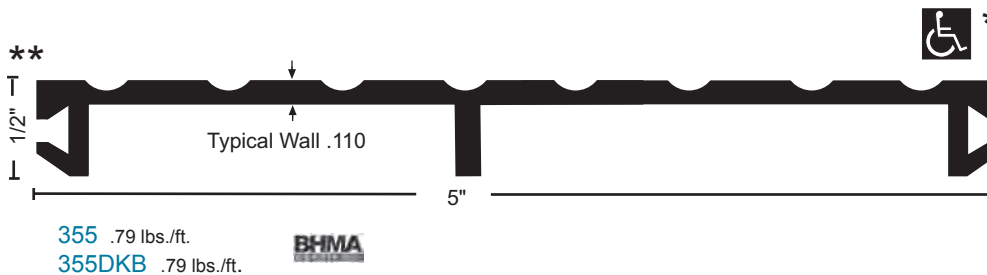
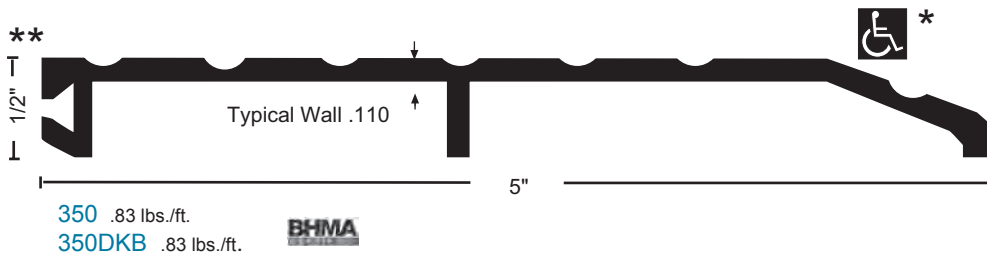
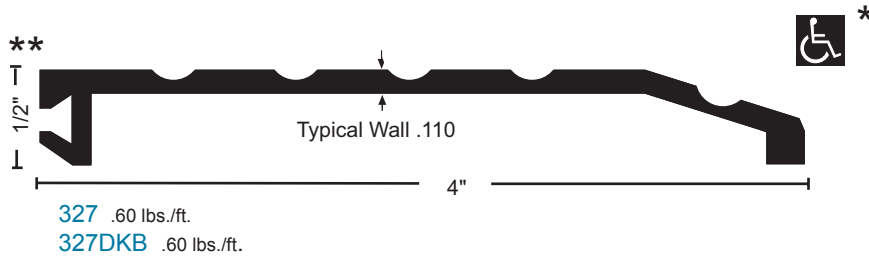
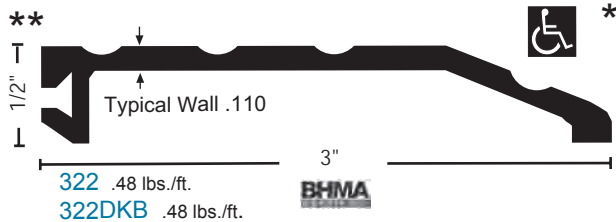
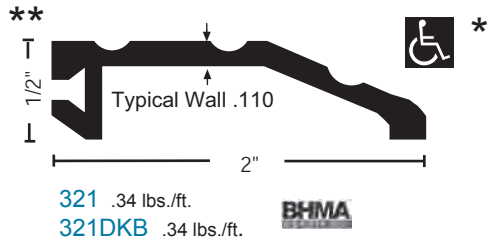

BUMPER SEAL

Seals against the door providing weather resistance

Vinyl ("V") supplied unless other material specified

- Options:
NGP-TPV ("N")
Silicone ("S")
Pile ("P")

- * When installed with the non-beveled edge FLUSH with flooring, or where no greater than 1/4" vertical rise occurs.

- ** Designed for thermal break. Bumper seal not available.

Extended Width Thresholds

- Create wider saddle or half saddle thresholds, choosing components from previous page.
- Furnished with aluminum spline for field assembly.

Examples - How to order:

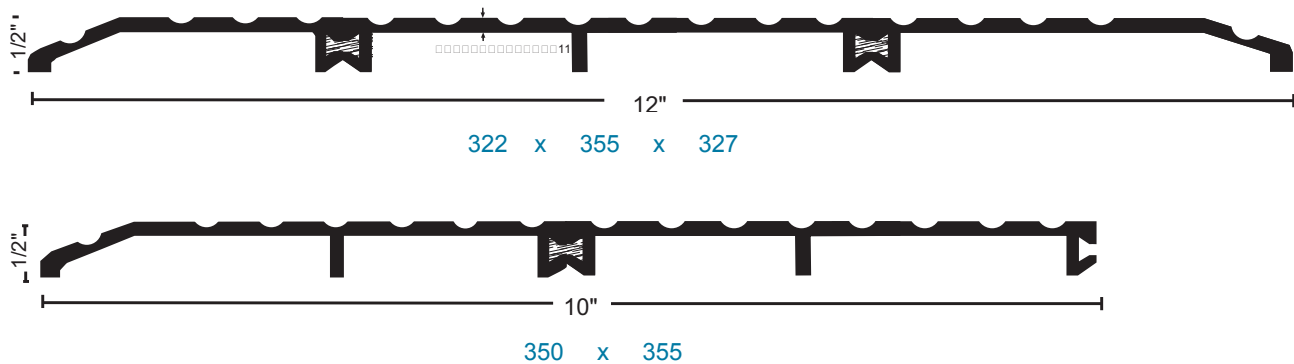

Thermal Break Extended Width Thresholds

- Create wider thermal break thresholds for non-fire-rated applications using components from previous page.
- Furnished with rigid PVC thermal break spline for field assembly - indicate "TH" where required.

Examples - How to order:

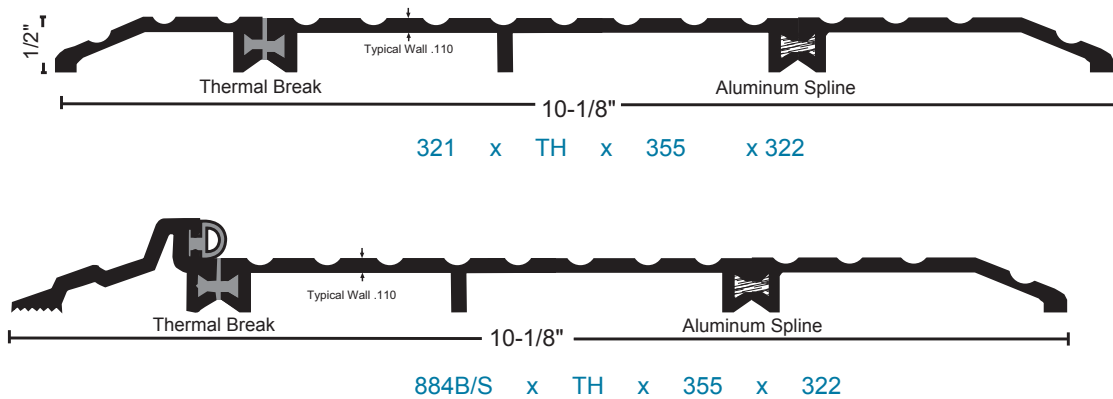

Thermal Break Saddle Thresholds

All thresholds this page

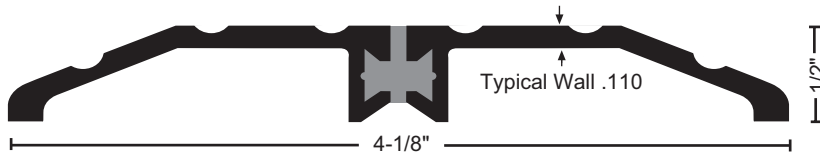

8424 .75 lbs./ft.
8424DKB .75 lbs./ft.



MATERIALS & FINISHES

- Aluminum mill finish
- DKB - Aluminum dark bronze finish



- Optional: Slip Resistant SIA Finish

FASTENERS

#10 x 1-1/2" FH zinc plated wood screws furnished. Dark bronze supplied with DKB thresholds.

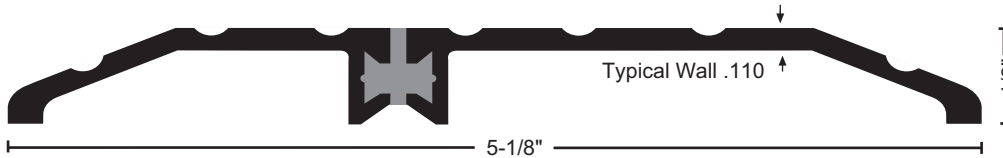

8425 .90 lbs./ft.
8425DKB .90 lbs./ft.

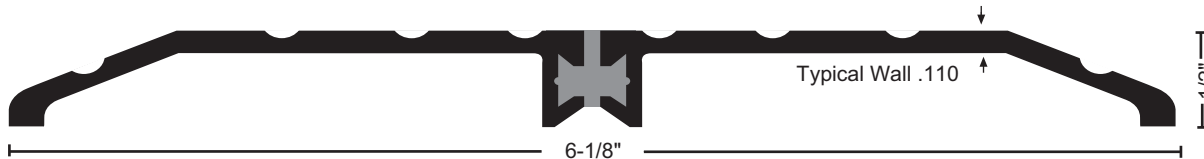

8426 1.00 lbs./ft.
8426DKB 1.00 lbs./ft.

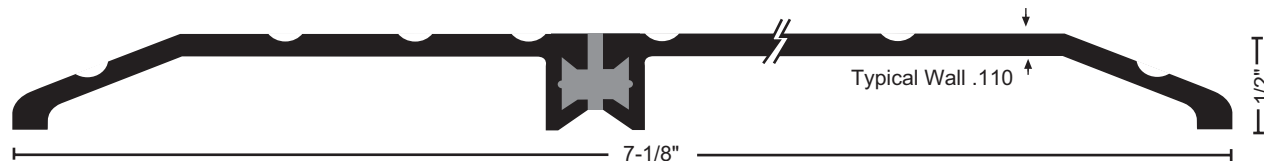

8427 1.20 lbs./ft.
8427DKB 1.20 lbs./ft.

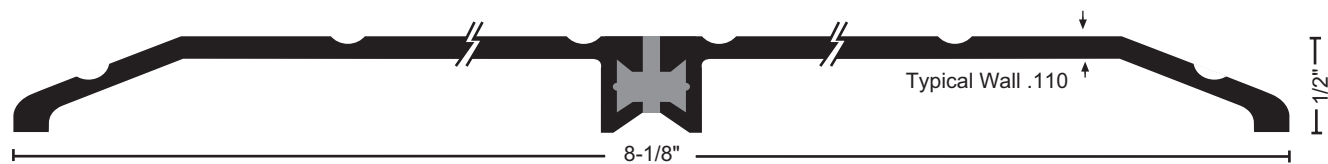

8428 1.30 lbs./ft.
8428DKB 1.30 lbs./ft.

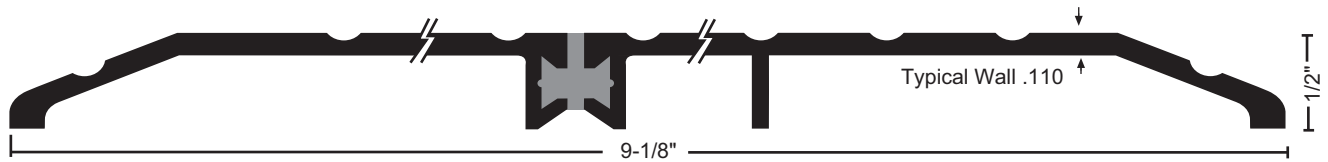

8429 1.60 lbs./ft.
8429DKB 1.60 lbs./ft.

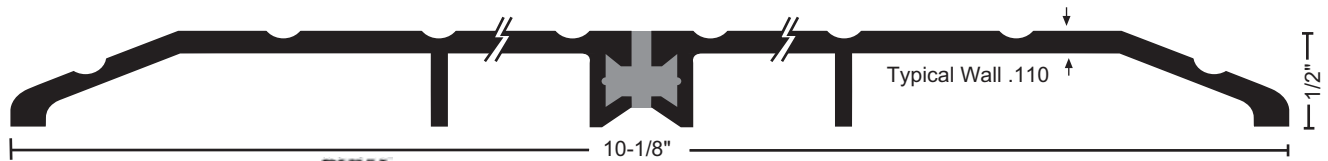

8430 1.70 lbs./ft.
8430DKB 1.70 lbs./ft.



Thermal Break Saddle Thresholds

All thresholds this page

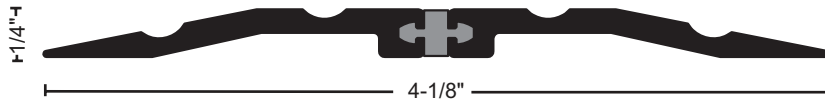

8413 .57 lbs./ft.
8413DKB .57 lbs./ft.

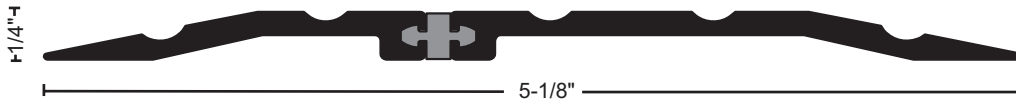

8513 .70 lbs./ft.
8513DKB .70 lbs./ft.

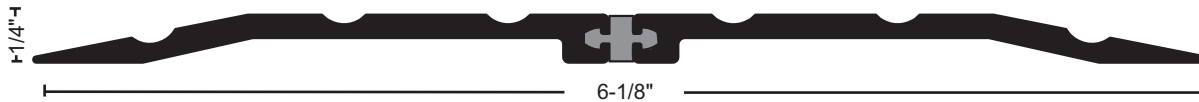

8613 .83 lbs./ft.
8613DKB .83 lbs./ft.



8713 .97 lbs./ft.
8713DKB .97 lbs./ft.



8813 1.11 lbs./ft.
8813DKB 1.11 lbs./ft.



8913 1.29 lbs./ft.
8913DKB 1.29 lbs./ft.



8013 1.42 lbs./ft.
8013DKB 1.42 lbs./ft.

MATERIALS & FINISHES

- Aluminum mill finish
- DKB - Aluminum dark bronze finish



- Optional: Slip Resistant SIA Finish

FASTENERS

#10 x 1-1/2" FH zinc plated wood screws furnished. Dark bronze supplied with DKB thresholds.

Thermal Break Saddle Thresholds

All thresholds this page 



8113 1.57 lbs./ft.
8113DKB 1.57 lbs./ft.



8213 1.74 lbs./ft.
8213DKB 1.74 lbs./ft.

MATERIALS & FINISHES

- Aluminum mill finish
- DKB - Aluminum dark bronze finish



• Optional: Slip Resistant SIA Finish

FASTENERS

#10 x 1-1/2" FH zinc plated wood screws furnished.
Dark bronze supplied with DKB thresholds.

Thermal Break Bumper Seal Thresholds

Thermal Break thresholds feature a rigid PVC spline creating a separation to prevent the transfer of outside temperature and frost through the threshold.

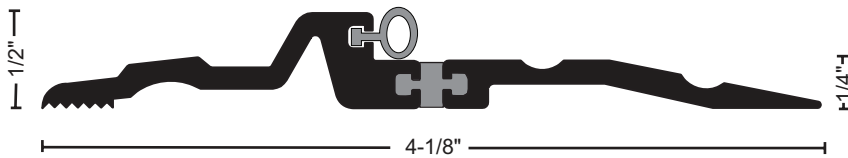

8433V .69 lbs./ft.
8433VDKB .69 lbs./ft.

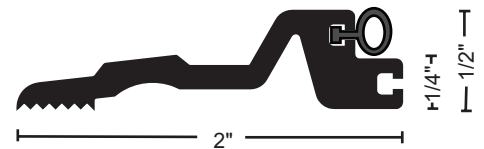

8423V .41 lbs./ft.
8423VDKB .41 lbs./ft.

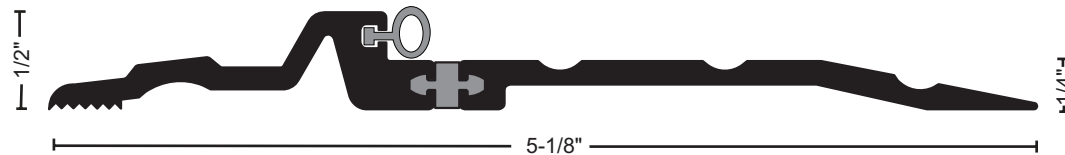

8533V .83 lbs./ft.
8533VDKB .83 lbs./ft.



BUMPER SEAL

Seals against the door providing weather resistance

Vinyl ("V") supplied unless other material specified

Options:

- NGP-TPV ("N")
- Silicone ("S")

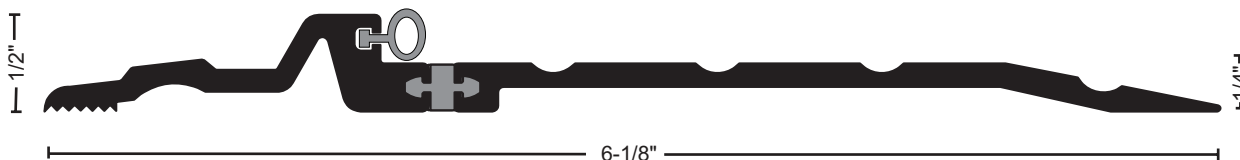

8633V .97 lbs./ft.
8633VDKB .97 lbs./ft.

Thermal Break Bumper Seal Thresholds

Thermal Break thresholds feature a rigid PVC spline creating a separation to prevent the transfer of outside temperature and frost through the threshold.

All thresholds this page 

MATERIALS & FINISHES

- Aluminum mill finish
- DKB - Aluminum dark bronze finish



- Optional: Slip Resistant SIA Finish

FASTENERS

#10 x 1-1/2" FH zinc plated wood screws furnished. Dark bronze supplied with DKB thresholds.

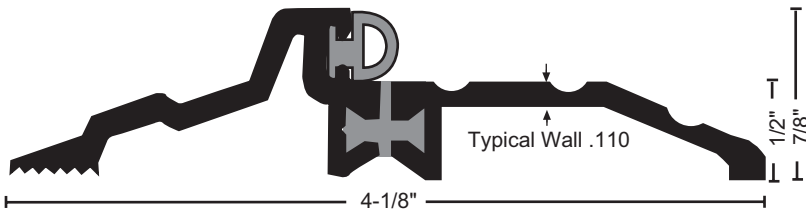

8434 .82 lbs./ft.
8434DKB .82 lbs./ft.

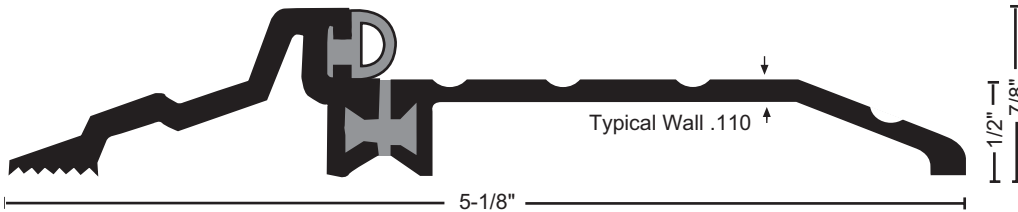

8435 .95 lbs./ft.
8435DKB .95 lbs./ft.

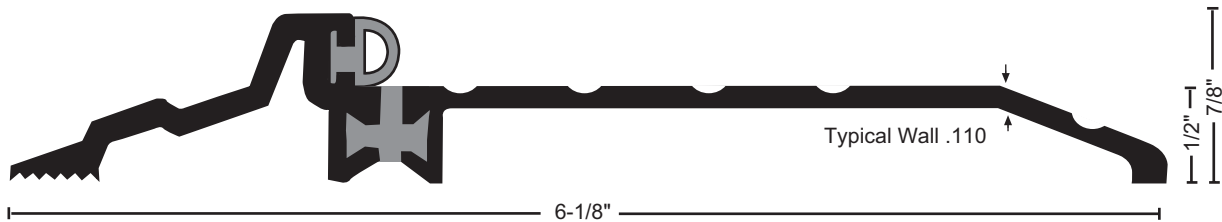

8436 1.11 lbs./ft.
8436DKB 1.11 lbs./ft.

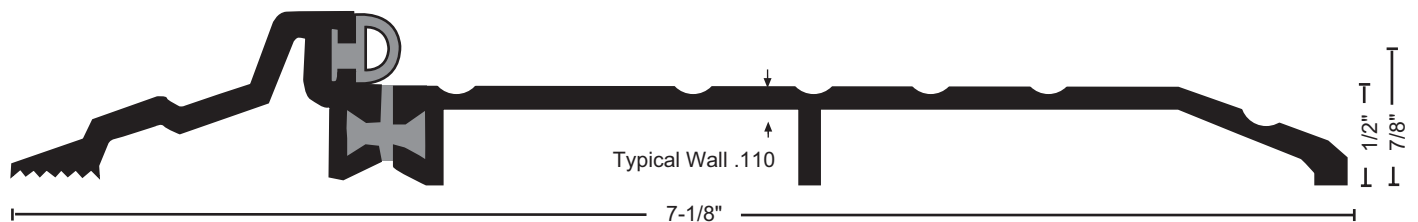

8437 1.29 lbs./ft.
8437DKB 1.29 lbs./ft.



BUMPER SEAL

Seals against the door providing weather resistance

Vinyl ("V") supplied unless other material specified

- Options:
- NGP-TPV ("N")
 - Silicone ("S")
 - Pile ("P")

Extended Width Bumper Seal Thresholds

All thresholds this page



884-6	1.10 lbs./ft.	6"
884-6DKB	1.10 lbs./ft.	
884-7	1.31 lbs./ft.	7"
884-7DKB	1.31 lbs./ft.	
884-8	1.52 lbs./ft.	8"
884-8DKB	1.52 lbs./ft.	



VINYL FOOT SEAL OPTION:
used instead of caulking to increase the weather resistance of the threshold. Specify on order.

Offset Bumper Seal Thresholds

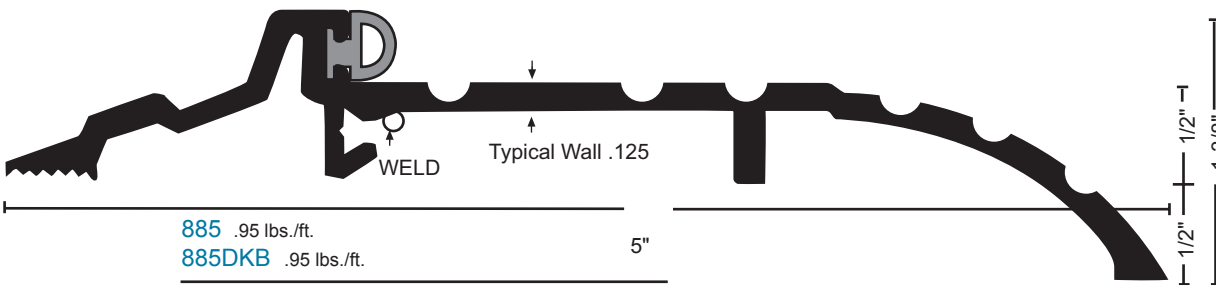

885	.95 lbs./ft.	5"
885DKB	.95 lbs./ft.	
885-6	1.16 lbs./ft.	6"
885-6DKB	1.16 lbs./ft.	
885-7	1.37 lbs./ft.	7"
885-7DKB	1.37 lbs./ft.	



BUMPER SEAL
Seals against the door providing weather resistance

Vinyl ("V") supplied unless other material specified

Options:
NGP-TPV ("N")
Silicone ("S")
Pile ("P")

MATERIALS & FINISHES

- Aluminum mill finish
- DKB - Aluminum dark bronze finish



- Optional: Slip Resistant SIA Finish

FASTENERS

#10 x 1-1/2" FH zinc plated wood screws furnished. Dark bronze supplied with DKB thresholds.

Interlocking Threshold

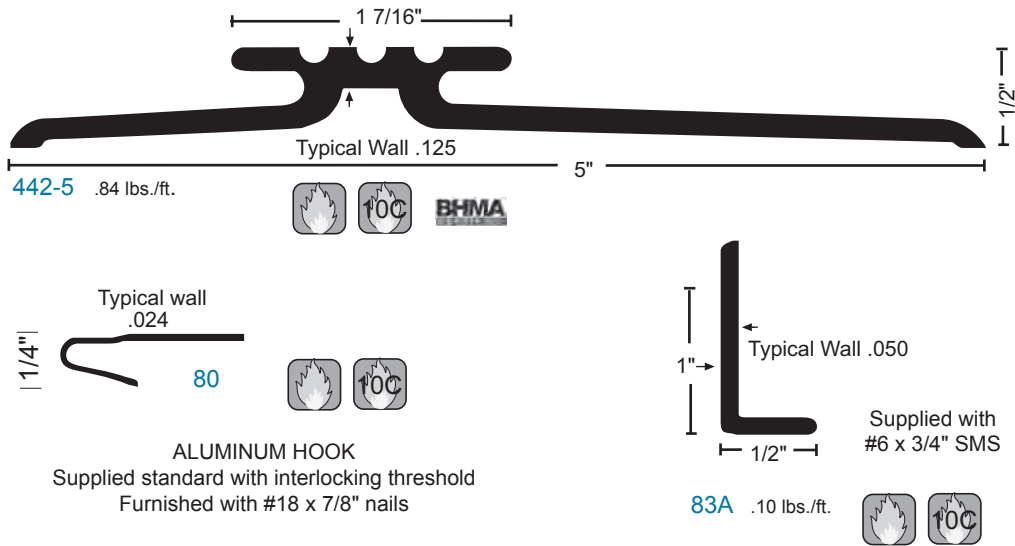

Vinyl Top Thresholds

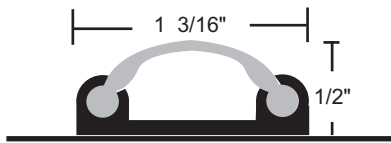

12V .31 lbs./ft.
12VDKB .31 lbs./ft.

MATERIALS & FINISHES

- Aluminum mill finish
- DKB - Aluminum dark bronze finish
- Optional: Slip Resistant SIA Finish

FASTENERS

#10 x 1-1/2" FH zinc plated wood screws furnished. Dark bronze supplied with DKB thresholds.

Elevators

Elevators are used under thresholds to increase the rise of the threshold or accommodate offset floor conditions.

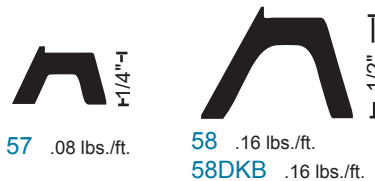

All elevators this section

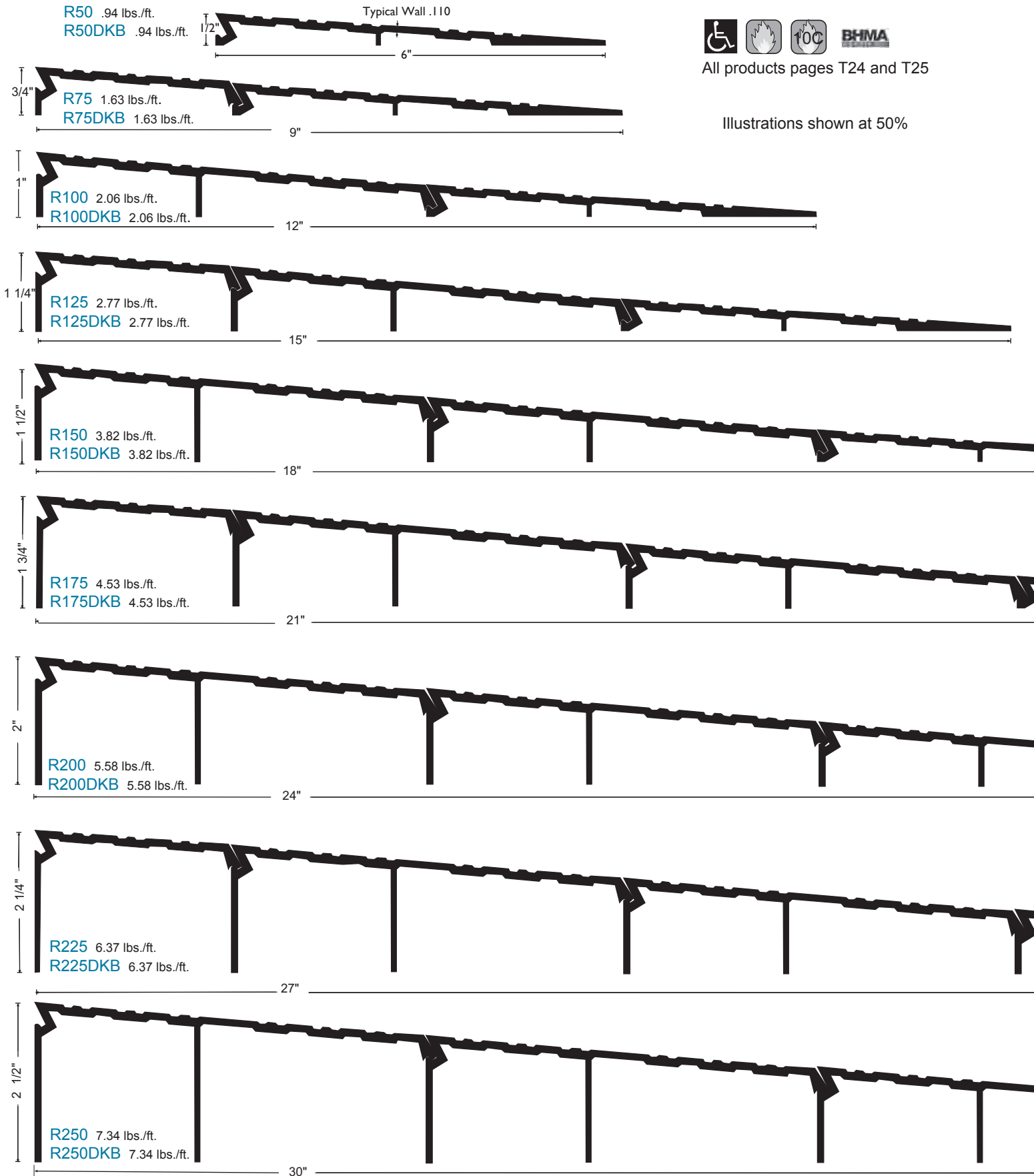

All products pages T24 and T25

Illustrations shown at 50%

ADA Compliant Interlocking Ramps

Return Closed Ends for Ramps

Return closed ends provide an attractive finished appearance to ramps. They are available in several lengths and can be trimmed to accommodate any size ramp assembly.

 RCE's are also available with slip-resistant "SIA" finish (suffix "SIA").



RCE-9
RCE-9DKB

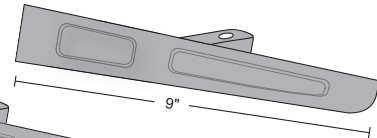

RCE-15
RCE-15DKB

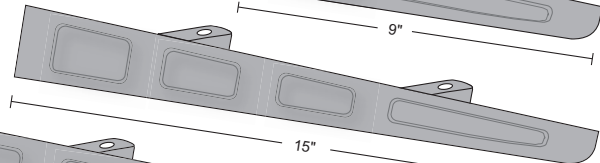

RCE-21
RCE-21DKB

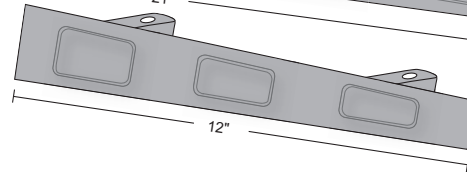
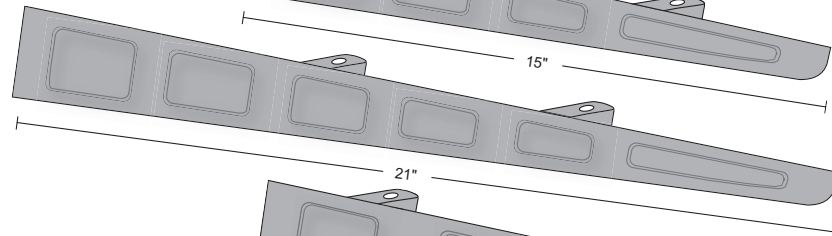

RCE-30 (includes RCE-21 + 12" extension)
RCE-30DKB (includes RCE-21 + 12" extension)

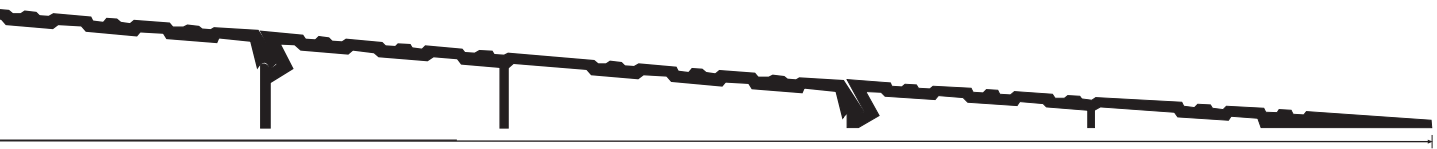
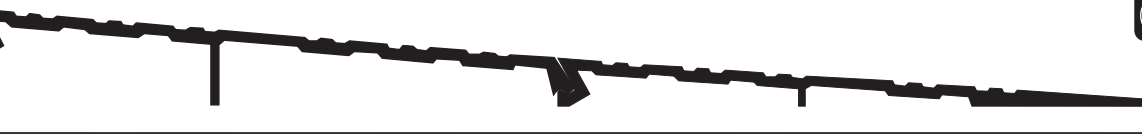

MATERIALS & FINISHES

- Aluminum mill finish
- DKB - Aluminum dark bronze finish



• Optional: Slip Resistant SIA Finish



ADA Compliant Interlocking Offset Ramps

All products pages T26 and T27



Available with Returned Closed Ends - See page T25

Slope = 1:12
Illustrations shown at 50%

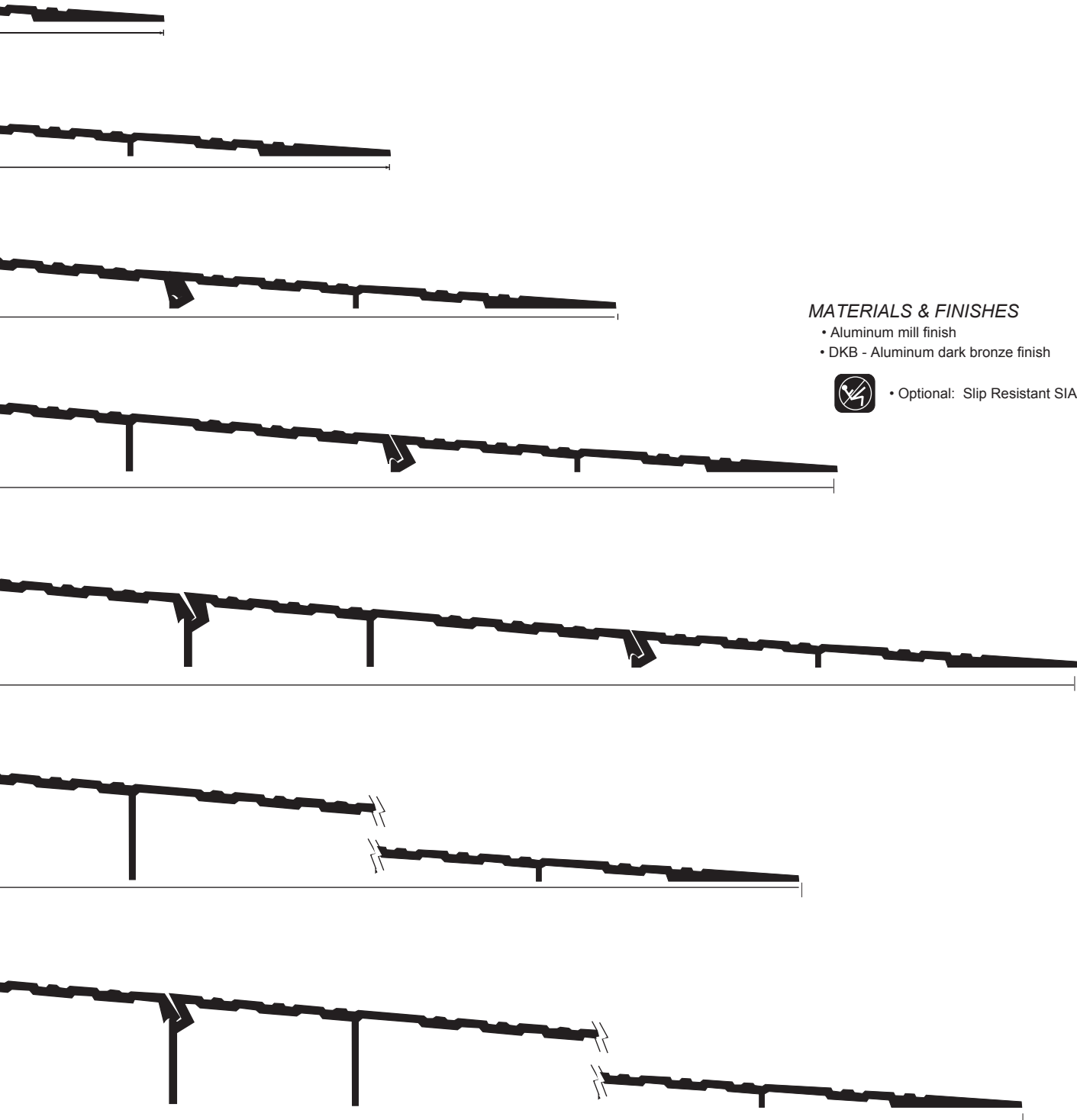

MATERIALS & FINISHES

- Aluminum mill finish
- DKB - Aluminum dark bronze finish



- Optional: Slip Resistant SIA Finish

Interlocking Ramp Components

Ramps Comply with:

- ADA Standards for Accessible Design.
- ICC/ANSI A117.1 Accessible and Usable Buildings and Facilities.

Requirements:

- Maximum Threshold Height = 1/2".
- Thresholds above 1/4" must be beveled with a slope no greater than 1:2.
- Height changes over 1/2" require use of a ramp with slope not steeper than 1:12.

All products this page



When installed as part of interlocking ramp assembly.

illustrations shown at 50%

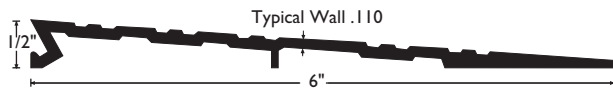

R50 .94 lbs./ft.
R50DKB .94 lbs./ft.

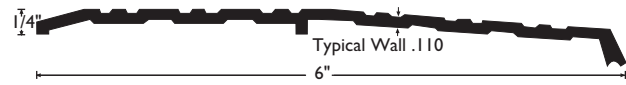

957 .93 lbs./ft.
957DKB .93 lbs./ft.

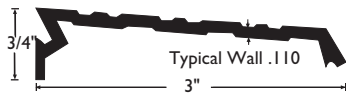

953 .69 lbs./ft.
953DKB .69 lbs./ft.

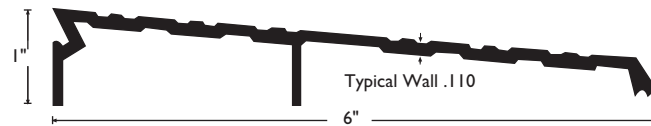

954 1.12 lbs./ft.
954DKB 1.12 lbs./ft.

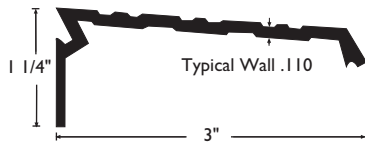

955 .71 lbs./ft.
955DKB .71 lbs./ft.

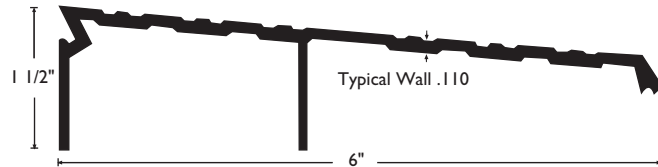

962 1.23 lbs./ft.
962DKB 1.23 lbs./ft.

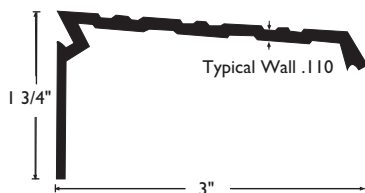

951 .71 lbs./ft.
951DKB .71 lbs./ft.

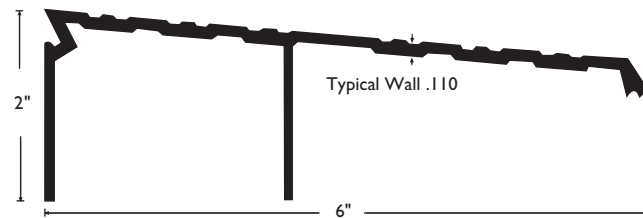

961 1.34 lbs./ft.
961DKB 1.34 lbs./ft.

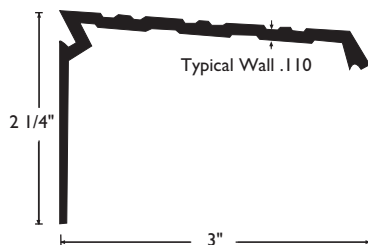

959 .79 lbs./ft.
959DKB .79 lbs./ft.

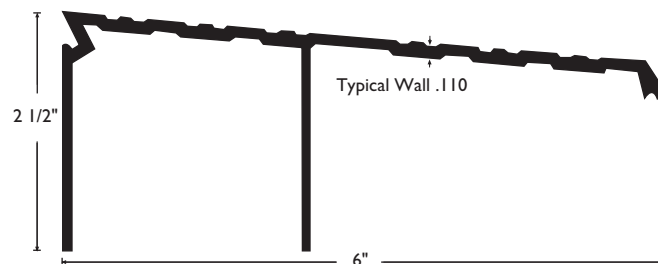

960 1.76 lbs./ft.
960DKB 1.76 lbs./ft.

Aluminum Ramps

All aluminum ramps this section

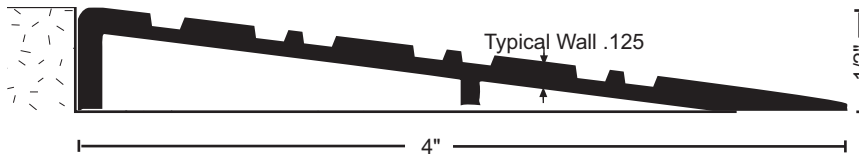

654 .53 lbs./ft.
654DKB .53 lbs./ft.

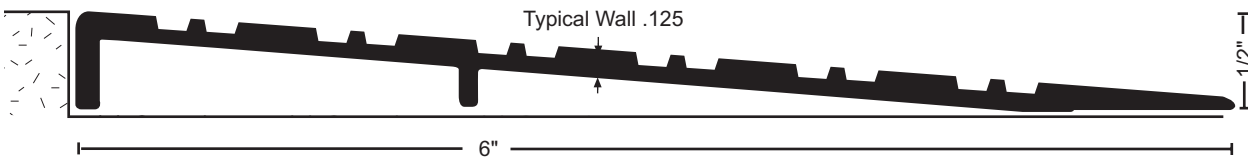

657 .86 lbs./ft.
657DKB .86 lbs./ft.



MATERIALS & FINISHES

- Aluminum mill finish
- DKB - Aluminum dark bronze finish



• Optional: Slip Resistant SIA Finish

Interlocking Rubber Ramps

- Supplied with beveled ends - (end slope = 1:2). Specify if straight cut is required.
- Rubber ramp sections may be combined with aluminum ramp components for higher rises, or with 6" flat aluminum interlocking threshold #957 for offset conditions.
- Black silicone adhesive available to secure ramps without fasteners. Specify RR5007BL, each tube will secure 2 ramps 12" wide x 36" long (6 square feet.)



RR42 3.4 lbs./ft.
maximum length = 118"



RR952 1.0 lbs./ft.
maximum length = 120"



Slope = 1:12
Illustrations shown at 50%

Custom Fabricated Thresholds

Choose from various height and width components to build custom thresholds to meet special job requirements. See the custom fabricated threshold example illustrated on page T4. For assistance contact our tech support team.

Select the proper height edge components. Select the appropriate center plates to construct the width needed. Plates may be butted together or ripped to make specific widths. Support joints and wider spans with bar supports.

Threshold assembly plates may be used fluted or smooth side up. Slip-resistant SIA finish can be applied to all parts.

Threshold assembly components may be ordered separately for field assembly or welded into one piece units in our custom fabrication shop. They are supplied undrilled unless a template is provided. Ripping and beveling options are available. All custom fabricated assemblies have a tolerance of +/- 1/16".

If a welded assembly is desired, specify "welded".

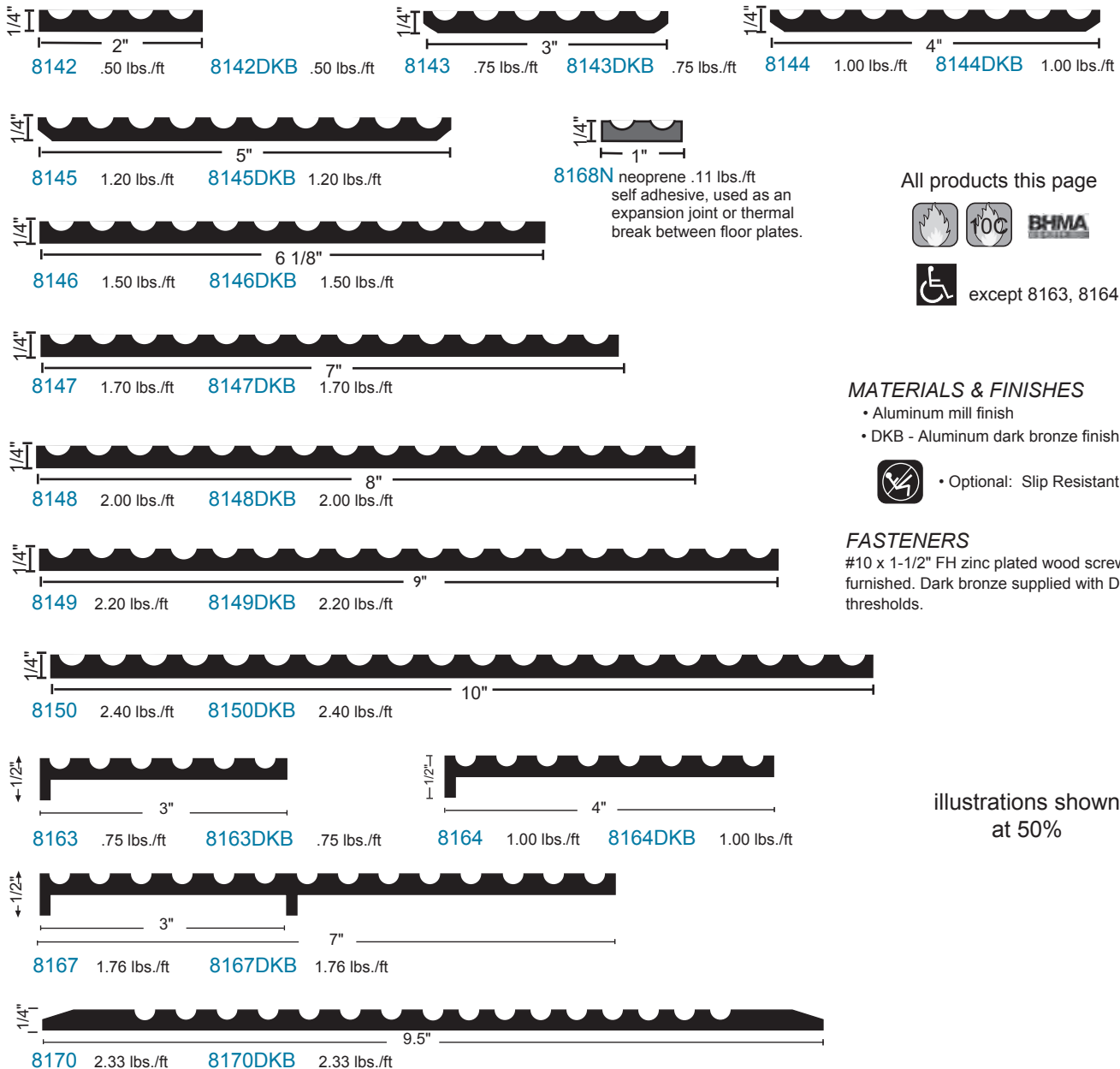

All products this page



except 8163, 8164, 8167

MATERIALS & FINISHES

- Aluminum mill finish
- DKB - Aluminum dark bronze finish



- Optional: Slip Resistant SIA Finish

FASTENERS

#10 x 1-1/2" FH zinc plated wood screws furnished. Dark bronze supplied with DKB thresholds.

illustrations shown
at 50%

Edge Components

All products this page   

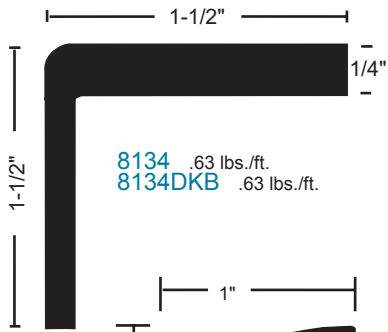

8134 .63 lbs./ft.
8134DKB .63 lbs./ft.

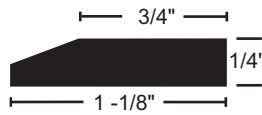

8136 .30 lbs./ft.
8136DKB .30 lbs./ft. 



8138 .27 lbs./ft.

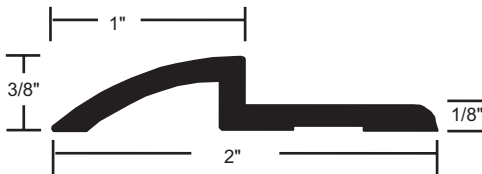

8133 .31 lbs./ft.
8133DKB .31 lbs./ft. 

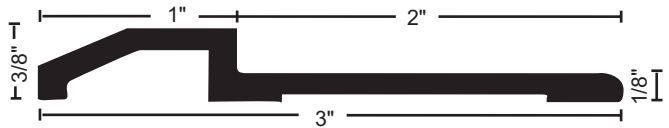

8139 .44 lbs./ft.
8139DKB .44 lbs./ft. 

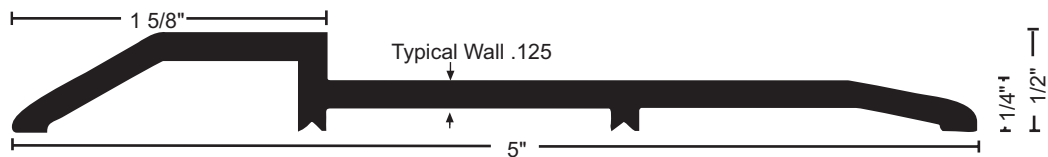

882 .83 lbs./ft.
882DKB .83 lbs./ft. 

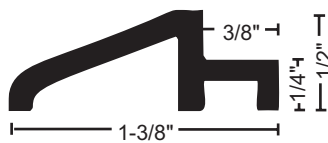

8137 .26 lbs./ft.
8137DKB .26 lbs./ft. 



8140 .28 lbs./ft.
8140DKB .28 lbs./ft. 

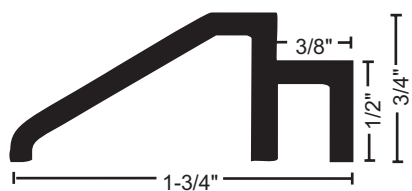

8141 .34 lbs./ft.
8141DKB .34 lbs./ft.

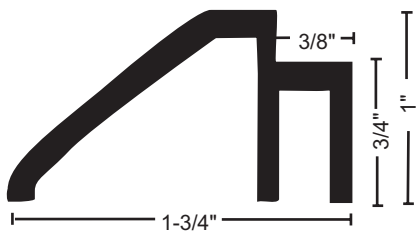

8152 .44 lbs./ft.
8152DKB .44 lbs./ft.

Bar Supports

Used as support under threshold assemblies

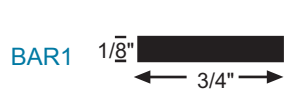

BAR1



BAR2



BAR4

Aluminum Cover Plates

All products this page



- Great for expansion joint covers or anywhere extra width and strength are required
- Cover plates are made to order; non-returnable and non-cancelable once fabricated
- Manufactured through a rolled process providing extra durability
- PVC coating applied to protect the finish during shipping and installation
- Minimum width 2" on 818, 3" on 814 and 4" on 838
- Edges are beveled unless otherwise specified
- Furnished undrilled although custom drilling is available to your detail
- #10 x 1-1/2" zinc plated wood screws furnished

MATERIALS & FINISHES

- Aluminum mill finish
- DKB - Aluminum dark bronze finish



• Optional: Slip Resistant SIA Finish

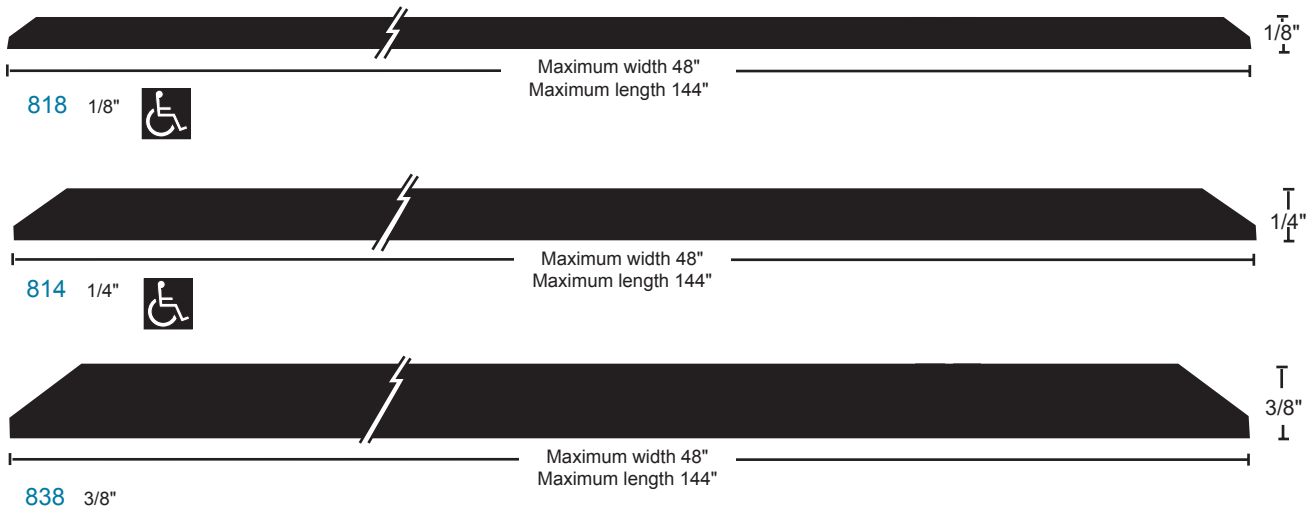

Stainless Steel Cover Plates

- #304 stainless steel material, mill finish
- Optional finishes: Polished US32, 629, suffix "POL",
Brushed US32D, 630, suffix "Brushed"
- PVC coating applied to protect the finish during shipping and installation.
- Square cut edges standard. Specify if beveled edge is required.
- Furnished undrilled although custom drilling is available to your detail.
- Minimum width 3" on 818SS and 4" on 814SS.
- #10 x 1-1/2" stainless steel wood screws furnished.

Optional Slip Resistant SIA Finish
Suffix "SIA"

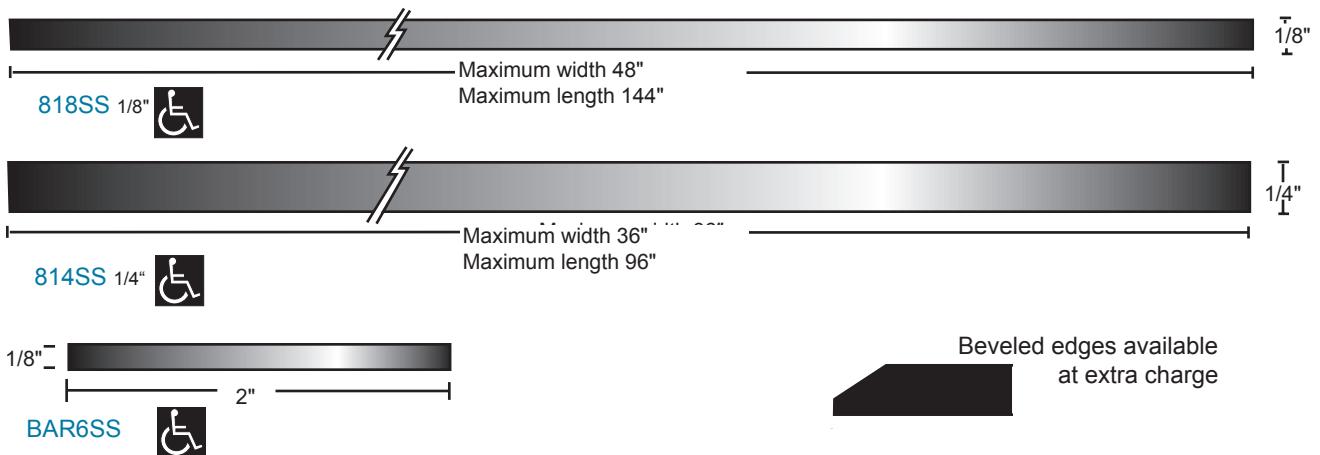

Diamond Tread Plate

- Great for expansion joint cover, bulkhead saddle, or anywhere extra width and strength are required
- This item is made to order and is non-returnable and non-cancelable once fabricated
- 1/8" thick bright-finish aluminum
- Edges beveled unless otherwise specified
- Furnished undrilled, although custom drilling is available to your detail
- #10 x 1-1/2" zinc plated wood screws furnished
- Minimum width 2"

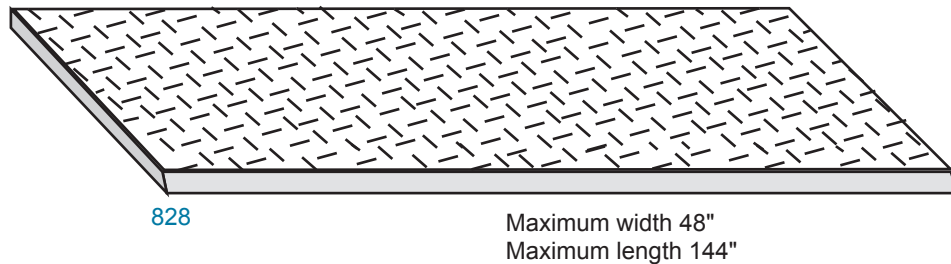

Safety Tread Plates

- Non-slip abrasive tread material is a blend of carborundum and aluminum oxide, bonded and locked into the aluminum tread base
- Treads exceed ADA requirements for coefficient of friction tested to ASTM F609 and MIL-D-23003A
The coefficient of friction for NGP safety tread plates is .94 dry and .86 wet
- Furnished undrilled, unless a template is provided
- May be used with edge parts (page T31)
- Treads can NOT be ripped to narrower width or welded together
- Safety treads are manufactured to order and are non-cancelable and non-returnable

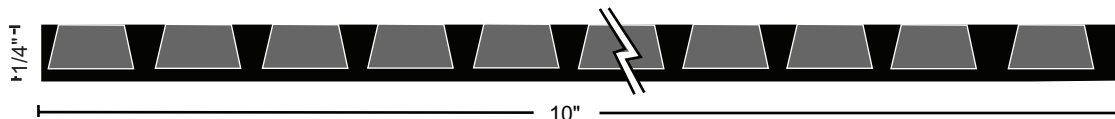
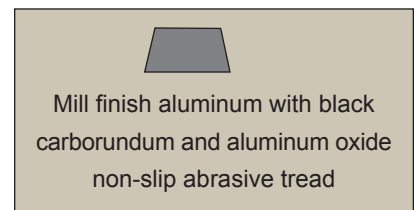

3510 4.15 lbs./ft.



3504 1.6 lbs./ft.



Safety Tread Stair Nosings

- Non-slip abrasive tread material is a blend of carborundum and aluminum oxide, bonded and locked into the aluminum tread base.
- Treads exceed ADA requirements for coefficient of friction tested to ASTM F609 and MIL-D-23003A. The coefficient of friction for NGP stair nosings is .94 dry and .86 wet
- Furnished drilled and countersunk for screws, except 3231 and 3241 which have hook anchor designed for installation into wet concrete.
- Furnished standard with #14 x 1-1/2" stainless steel wood screws. Specify if other screws and anchors required.
- Stair nosings are manufactured to order and are non-cancelable and non-returnable.

Renovation Nosings

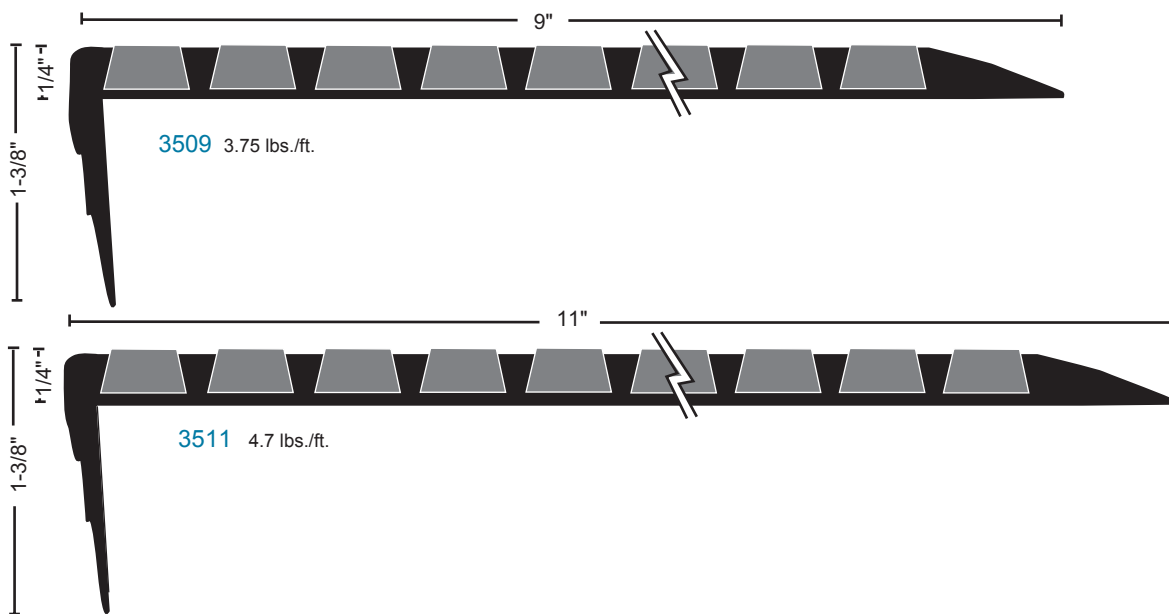

Safety Nosings

- Designed for new construction: poured concrete, Terrazzo or Steel Pan cement filled stairs.
- Continuous hook anchor. Not drilled, no screws provided

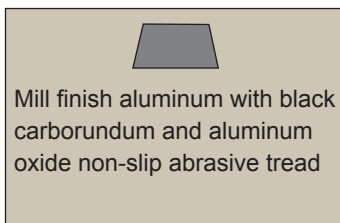
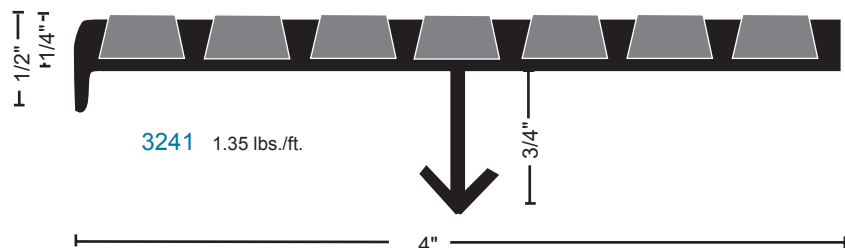
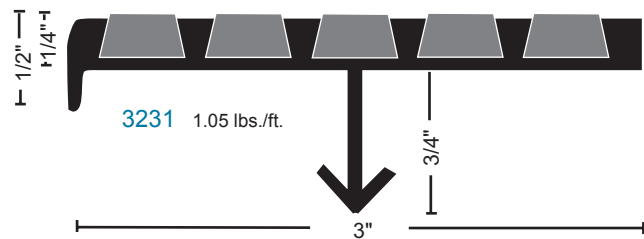

Cast Aluminum Thresholds With Abrasive Surface

All products this page



- STANDARD FASTENERS - #14 stainless steel wood screws x expansion shields
- STOCK LENGTHS - 36", 48", 72". 4425 available also in 96" length.
- Saddle type with fluted abrasive surface (flute details may vary slightly)
- Drilled 6" from each end to allow field cutting or notching
- Other profiles and sizes available on special order - Consult Factory
- Cast Threshold dimensions shown below are nominal.
Tolerance +/- 1/16".

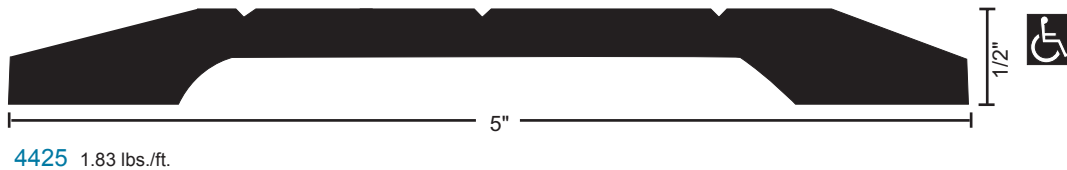

Floor Closer Thresholds

Thresholds can be fabricated for use with any floor closer. They are available in aluminum, bronze, or stainless steel in several finishes including slip resistant (SIA) finish.

Specify when ordering:

- Type x number (i.e. Type 3 x 427FC)
- Material and finish
- Door opening width
- Door thickness if other than 1-3/4"
- Handing (Door Handing)
- Closer manufacturer
- Closer model number

TYPES 1, 3, & 4

ALUMINUM

1/2" x 6-3/4"	427FC
1/2" x 7-3/4"	428FC
1/4" x 6-3/4"	713FC
1/4" x 7-3/4"	813FC
1/2" x 9"	429E
1/2" x 10"	430E
1/4" x 9"	913
1/4" x 10"	1013

ARCHITECTURAL BRONZE

1/2" x 7"	427BR
1/2" x 8"	428BR
1/4" x 7"	713BR
1/4" x 8"	813BR

TYPE 5

ALUMINUM

1/2" x 6-3/4" x 3-3/4"	427FC x 424FC	1/2" x 7" x 4"	427BR x 424BR
1/4" x 6-3/4" x 3-3/4"	713FC x 413FC	1/4" x 7" x 4"	713BR x 413BR
1/2" x 7-3/4" x 4-3/4"	428FC x 425FC	1/2" x 8" x 5"	428BR x 425BR
1/4" x 7-3/4" x 4-3/4"	813FC x 513FC	1/4" x 8" x 5"	813BR x 513BR

ARCHITECTURAL BRONZE

OFFSET HUNG

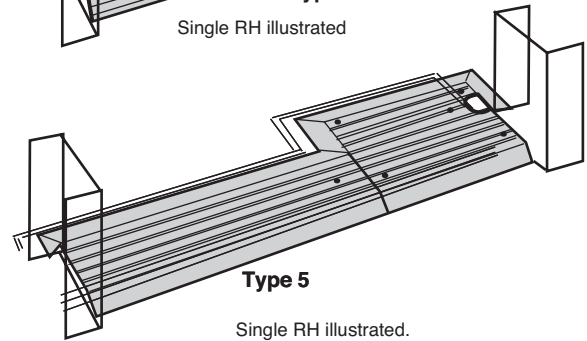
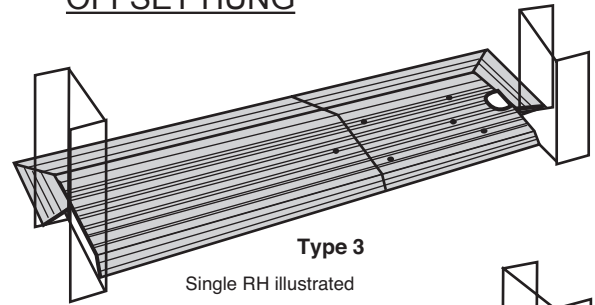

CENTER HUNG

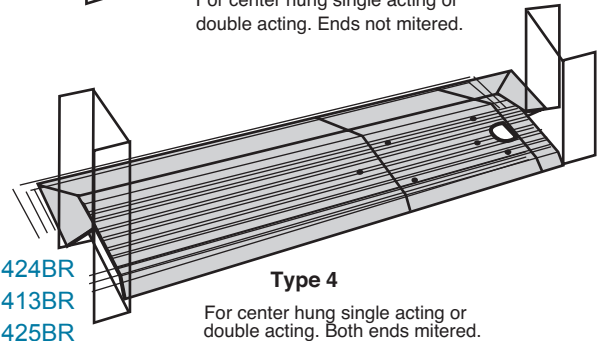
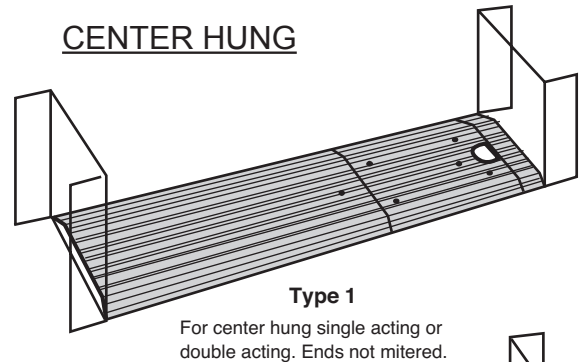

Other thresholds and custom assemblies may be prepped for floor closers. Consult factory for custom applications.

Special Finishes available

- Polished, suffix "POL"
- Dark oxidized bronze US10B, suffix "DKB"
- Slip-resistant SIA finish, suffix "SIA" 

Stainless steel available

- Specify type (1, 3 or 4) x stainless steel threshold model number

Optional Finishes:

- Polished US32, 629, suffix "POL"
- Brushed US32D, 630, suffix "Brushed"

Floor Closer Thresholds

All thresholds this page

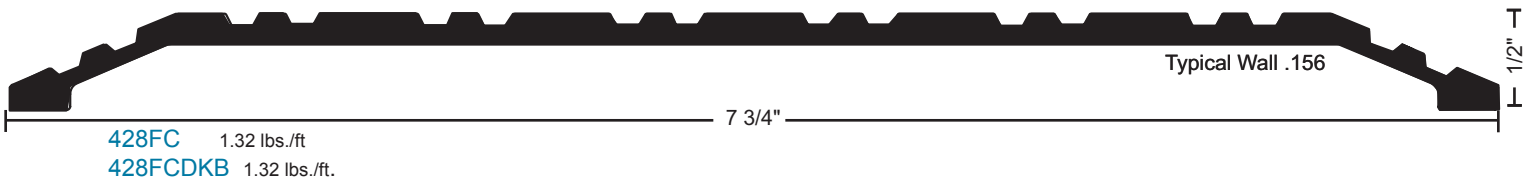
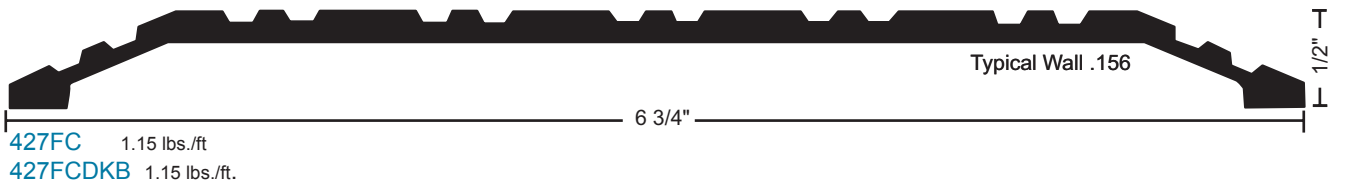
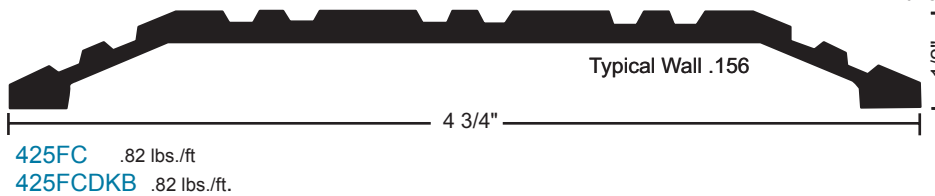
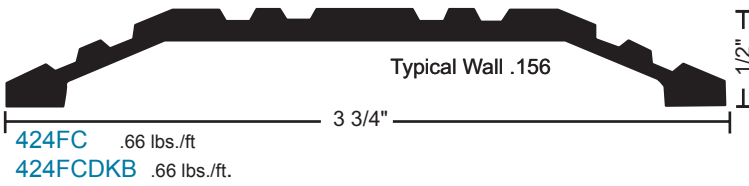
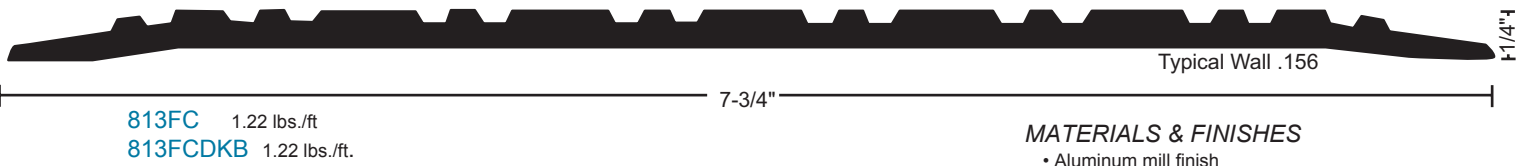
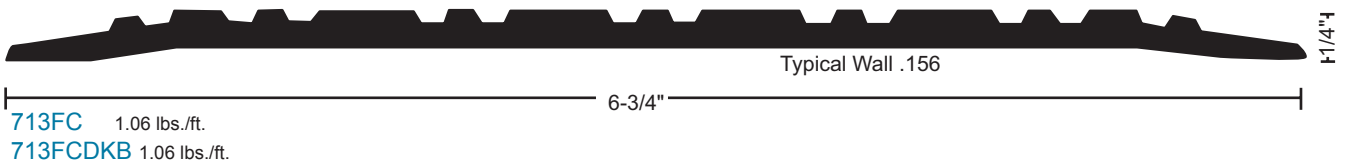
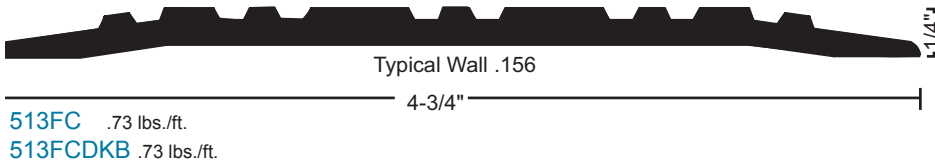
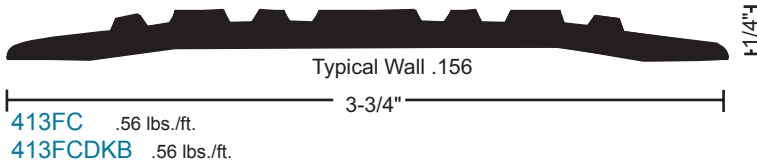

MATERIALS & FINISHES

- Aluminum mill finish
- DKB - Aluminum dark bronze finish



- Optional: Slip Resistant SIA Finish

FASTENERS

#10 x 1-1/2" FH zinc plated wood screws furnished. Dark bronze supplied with DKB thresholds.

Stainless Steel 1/4" Saddle Thresholds

All thresholds this page



Widths and heights other than shown are available upon request.
Return Closed Ends are available - see page T4
Stainless steel thresholds are type #304, mill finish

Optional Finishes:

- Polished US32, 629 suffix "POL"
- Brushed US32D, 630 suffix "Brushed"
-  Slip-resistant suffix "SIA"

FASTENERS

#10 x -1-1/2" FH stainless steel wood screws

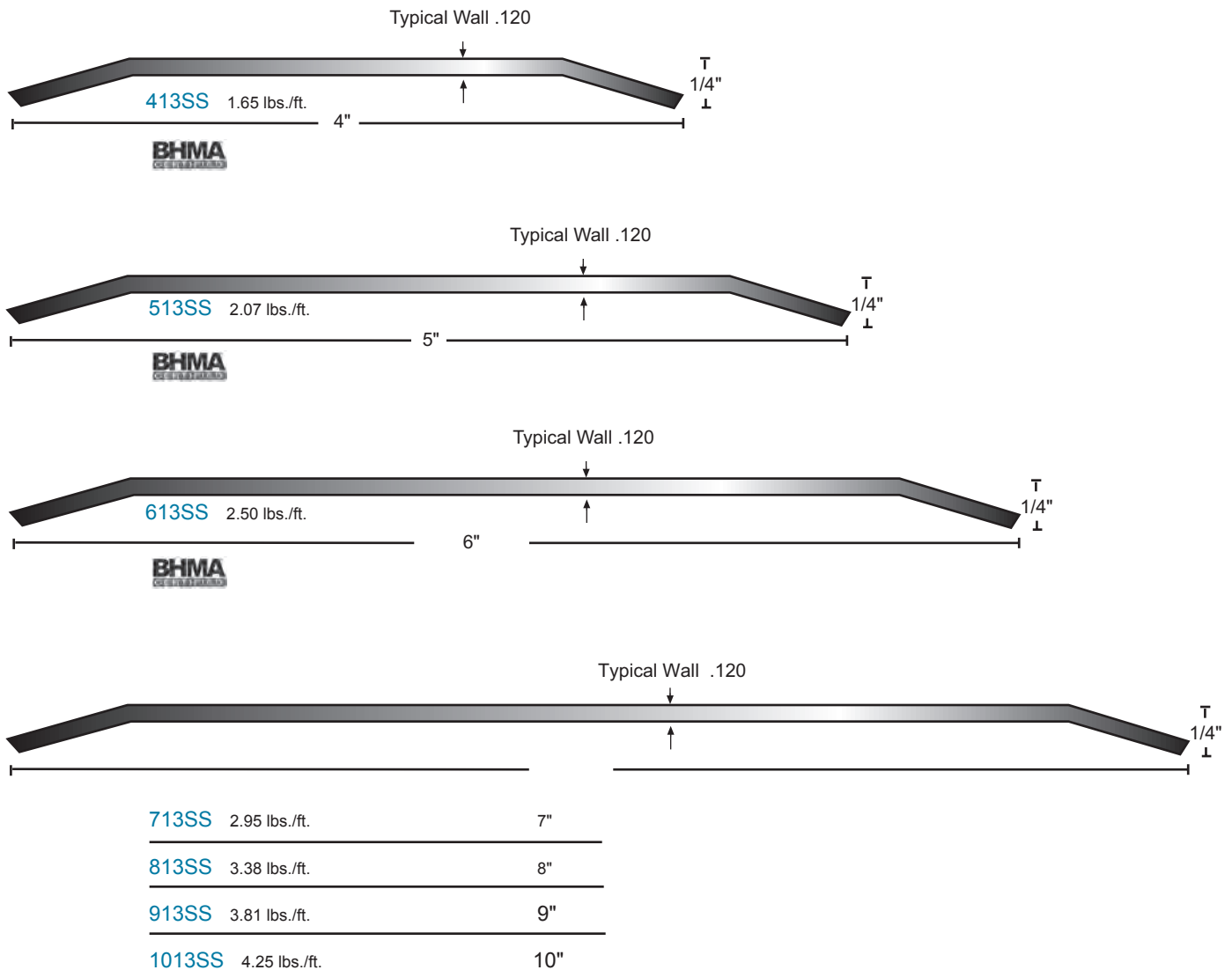

Stainless Steel 1/2" Saddle Thresholds

Widths and heights other than shown are available upon request.
 Return Closed Ends are available - see page T4
 Stainless steel thresholds are type #304, mill finish



Optional Finishes:
 Polished US32, 629 suffix "POL"
 Brushed US32D, 630 suffix "Brushed"
 Slip-resistant suffix "SIA"

FASTENERS
 #10 x -1-1/2" FH stainless steel wood screws

All thresholds this page   

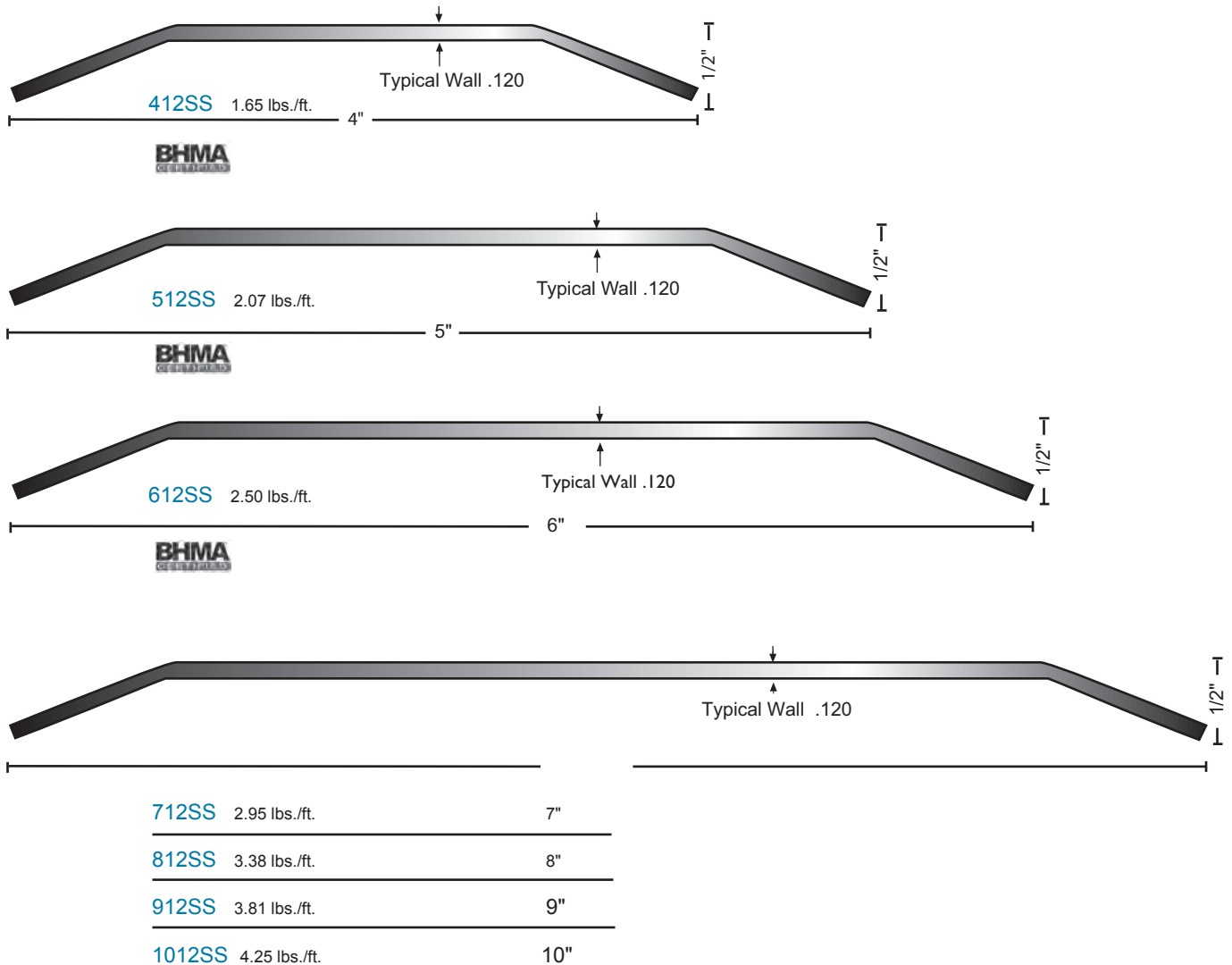

Stainless Steel Bumper Seal Thresholds

#304 stainless steel, mill finish

Optional finishes:

Polished US32, 629 suffix "POL"

Brushed US32D, 630 suffix "Brushed"

 Slip-resistant suffix "SIA"

All products this page

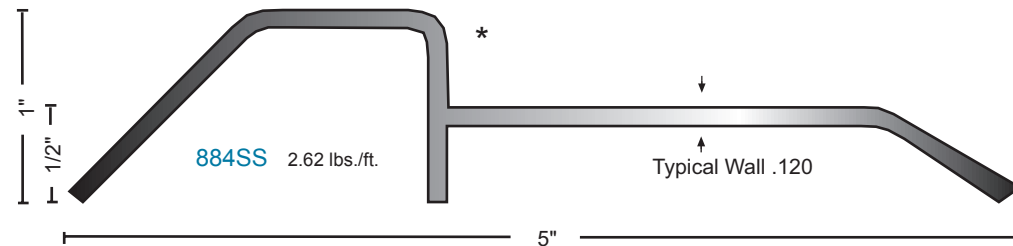
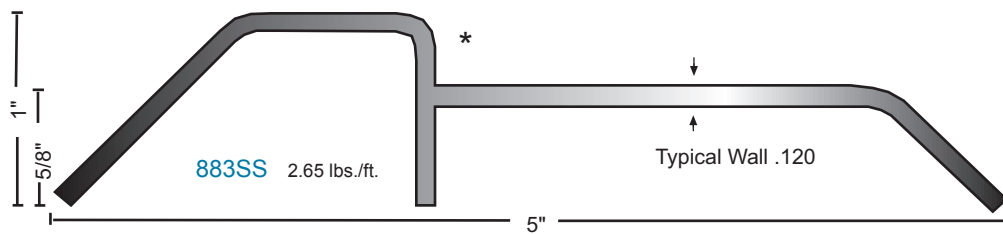
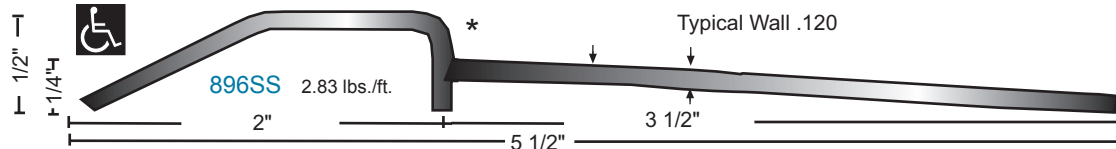

* OPTIONAL BUMPER SEAL

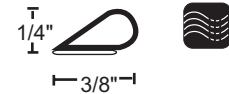

For adhesive mounted silicone bumper seal suffix "S"

Stainless Steel Cover Plate

#304 stainless steel material, Mill finish

Optional finishes: Polished US32, 629 suffix "POL"

Brushed US32D, 630 suffix "Brushed"

- PVC coating applied to protect the finish during shipping and installation.
- Square cut edges standard. Specify if beveled edge is required.
- Furnished undrilled although custom drilling is available to your detail.
- Minimum width 3" on 818SS and 4" on 814SS.
- #10 x 1-1/2" stainless steel wood screws furnished.



Beveled edges available at extra charge

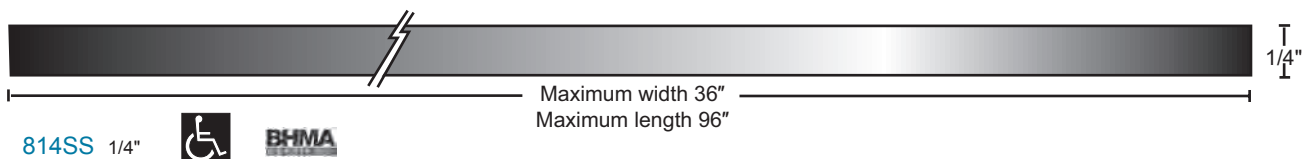
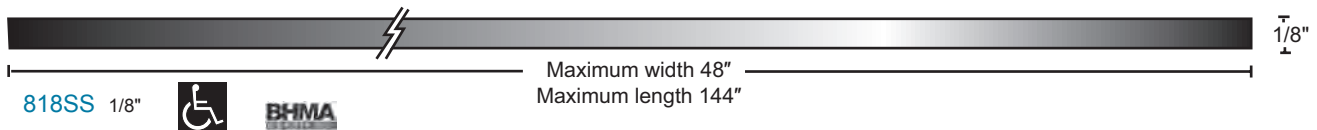

 Optional: Slip Resistant SIA Finish Suffix "SIA".

Architectural Bronze Bumper Seal Thresholds

Architectural Bronze satin finish (728) similar to US4.

Optional finishes:

Polished (721), suffix "POL"

Dark oxidized oil rubbed (722) similar to US10B, suffix "DKB"



Slip-resistant, suffix "SIA"

All products this page

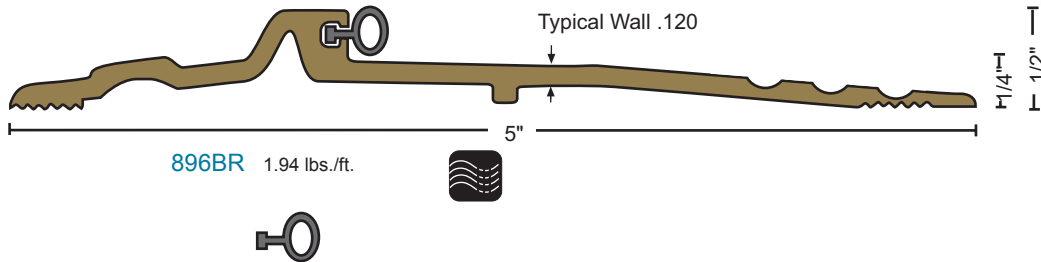
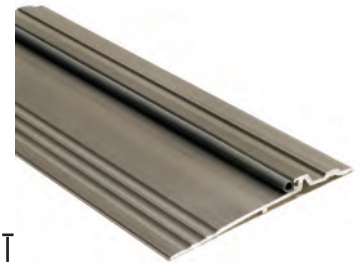

BUMPER SEAL

Seals against the door providing weather resistance

Vinyl ("V") supplied unless other material specified

Options:
NGP-TPV ("N")
Silicone ("S")

Brass Cover Plate

- #260 Brass, mill finish - 3" minimum width.
- Optional finish: Polished (similar to US3), suffix "POL".
- Manufactured through a cold formed process providing extra durability.
- PVC coating applied to protect the finish during shipping and installation.
- Beveled edges standard. Specify if square cut edges are required.
- Furnished undrilled although custom drilling is available to your detail.
- Minimum width 3".
- #10 x 1-1/2" brass wood screws furnished.

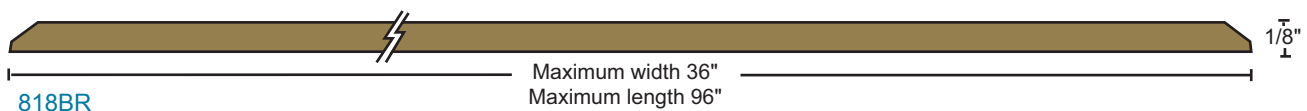

Optional: Slip Resistant SIA Finish
Suffix "SIA".

Architectural Bronze 1/4" Saddle Thresholds

All thresholds this page



Architectural Bronze satin finish (728) similar to US4.

Optional finishes:

Polished (721), suffix "POL"

Dark oxidized oil rubbed (722)

similar to US10B, suffix "DKB"

Slip-resistant, suffix "SIA"



FASTENERS

#10 X 1-1/2" solid brass wood screws furnished.

Antique bronze finish screws provided with dark bronze thresholds.

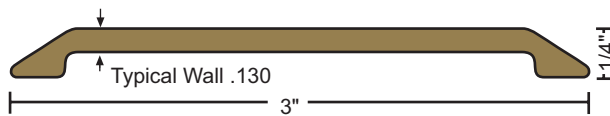

411BR 1.42 lbs./ft.

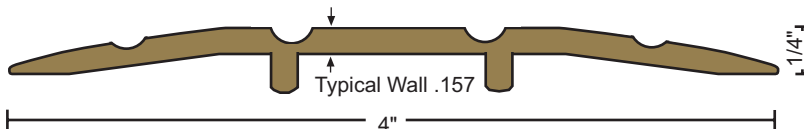

413BR 1.52 lbs./ft.

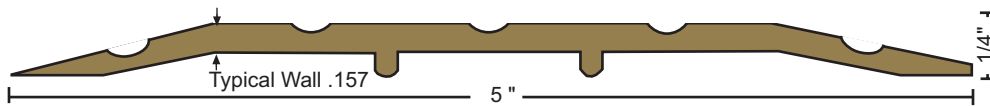

513BR 1.96 lbs./ft.

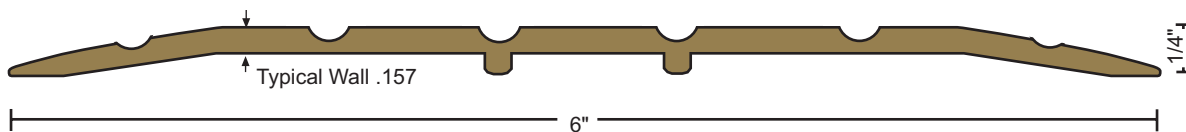

613BR 3.06 lbs./ft.

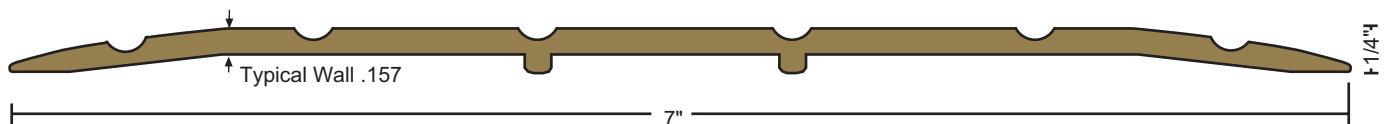

713BR 3.62 lbs./ft.

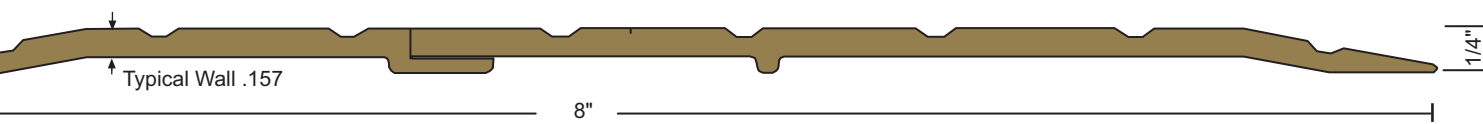

813BR 4.60 lbs./ft.

Architectural Bronze 1/2" Saddle Thresholds

All thresholds
this page



Architectural Bronze satin finish (728) similar to US4.

Optional finishes:

Polished (721), suffix "POL"

Dark oxidized oil rubbed (722) similar to US10B, suffix "DKB"



Slip-resistant, suffix "SIA"

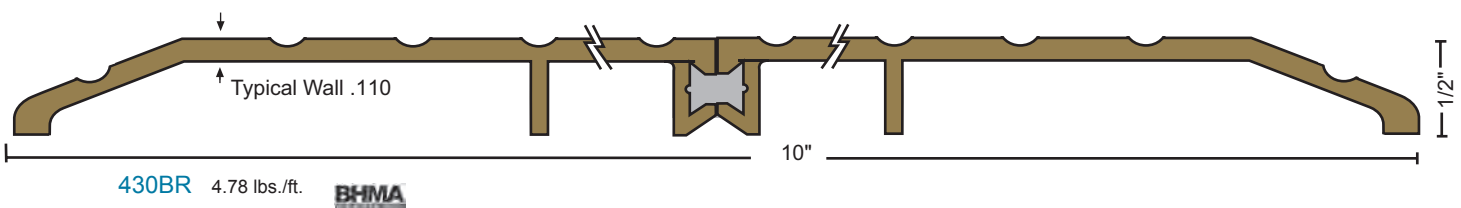
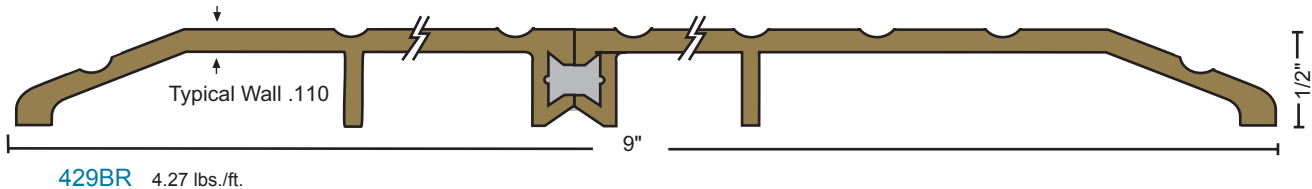
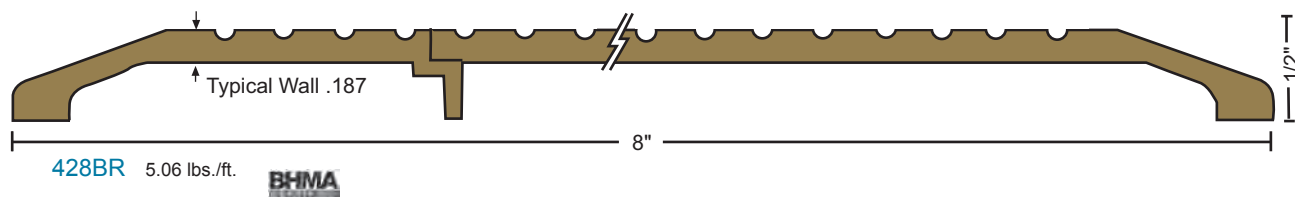
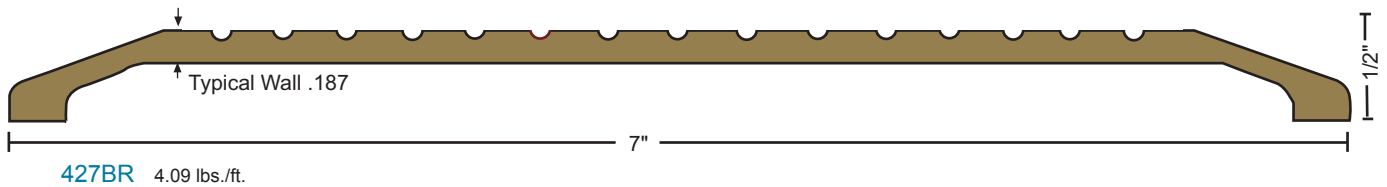
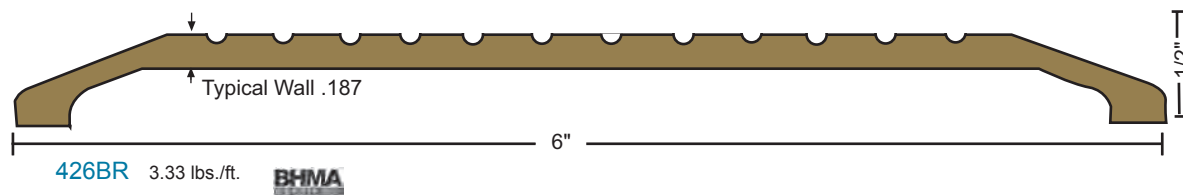
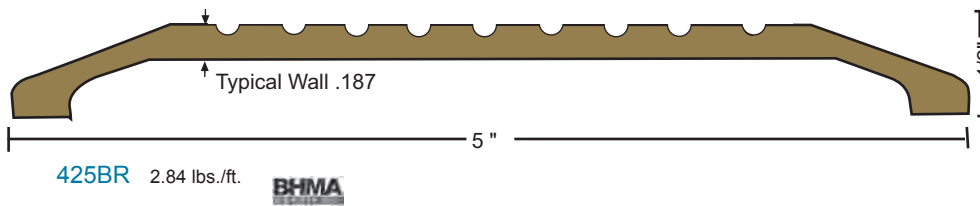
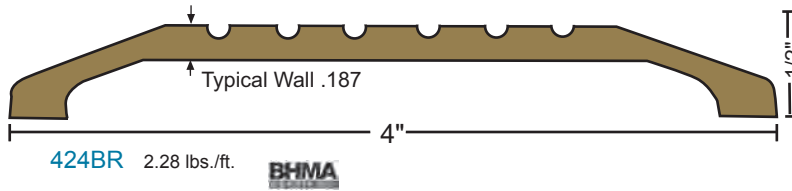

Architectural Bronze Thermal Break Saddle Thresholds

All Thresholds this Page

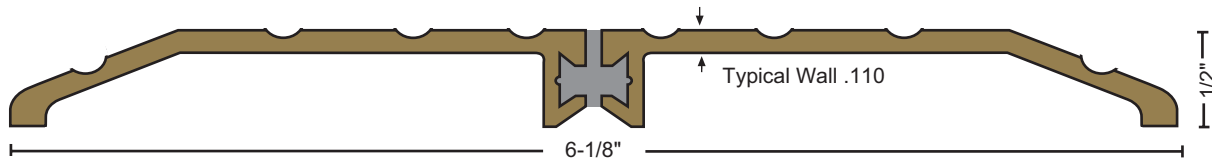

8426BR 2.84 lbs./ft.

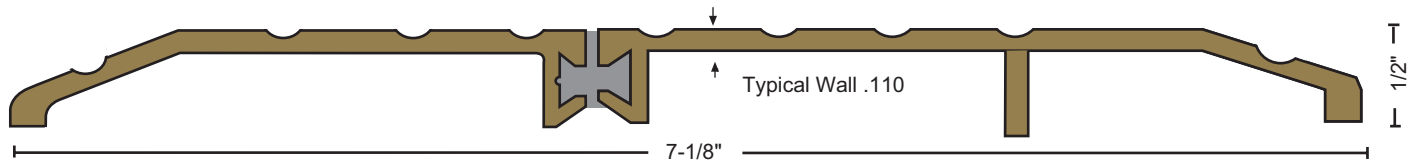

8427BR 3.23 lbs./ft.

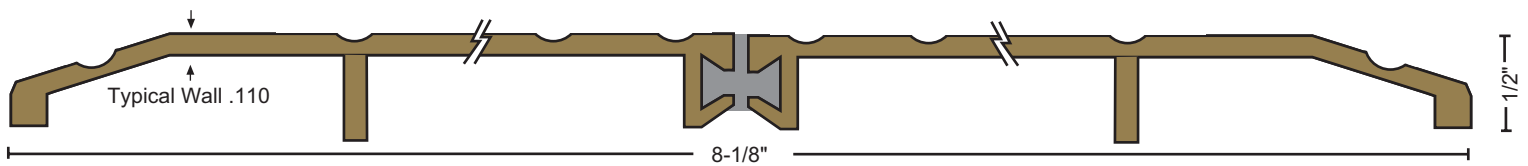

8428BR 3.62 lbs./ft.

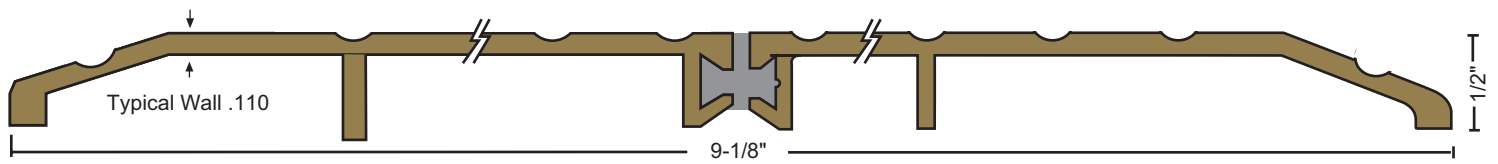

8429BR 4.16 lbs./ft.

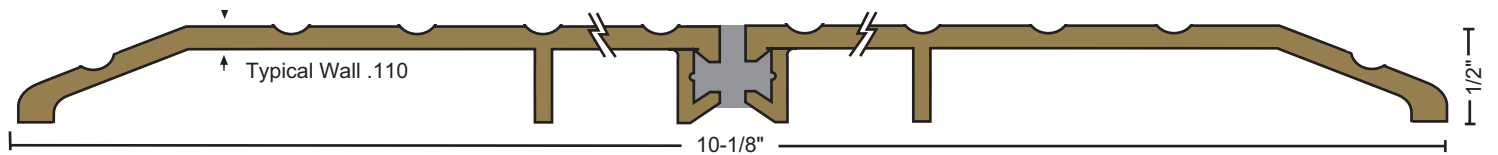

8430BR 4.70 lbs./ft.



Architectural Bronze satin finish (728) similar to US4.

Optional finishes:

Polished (721), suffix "POL"

Dark oxidized oil rubbed (722)

similar to US10B, suffix "DKB"



Slip-resistant, suffix "SIA"

FASTENERS

#10 X 1-1/2" solid brass

wood screws furnished.

Antique bronze finish screws provided with dark bronze thresholds.

Architectural Bronze Half-Saddle Thresholds

All products this page



* when installed with the non-beveled edge FLUSH with flooring, or where no greater than 1/4" vertical rise occurs.

Architectural Bronze satin finish (728) similar to US4.

Optional finishes:

Polished (721), suffix "POL"

Dark oxidized oil rubbed (722)

similar to US10B, suffix "DKB"

Slip-resistant, suffix "SIA"



FASTENERS

#10 X 1-1/2" solid brass wood screws furnished.

Antique bronze finish screws provided with dark bronze thresholds.

215BR .76 lbs./ft.

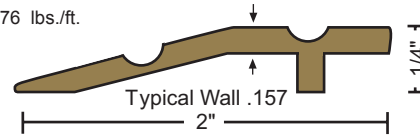

315BR 1.56 lbs./ft.

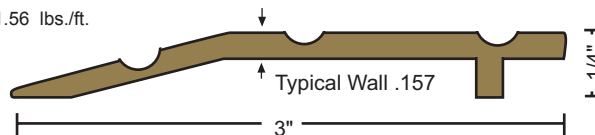

415BR 1.88 lbs./ft.

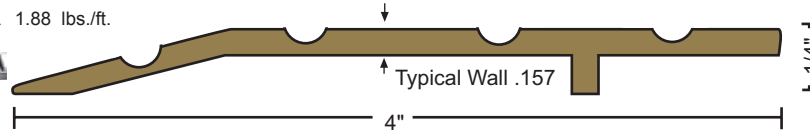

322BR 1.31 lbs./ft.

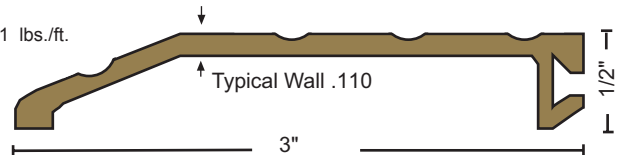

Not intended for insert

327BR 1.75 lbs./ft.

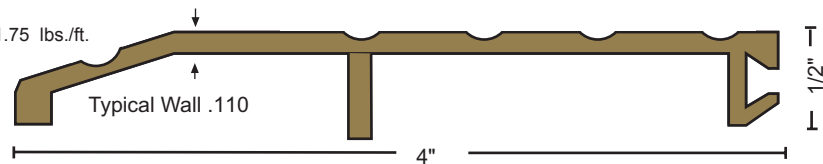

Not intended for insert

350BR 2.10 lbs./ft.

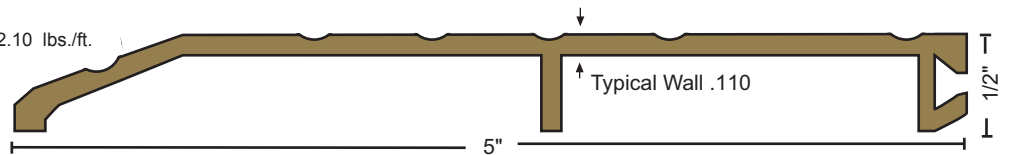

Not intended for insert

325BR 3.95 lbs./ft.

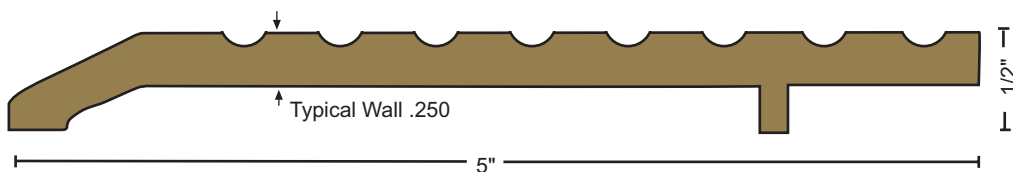

Architectural Bronze Interlocking Thresholds

All products this page

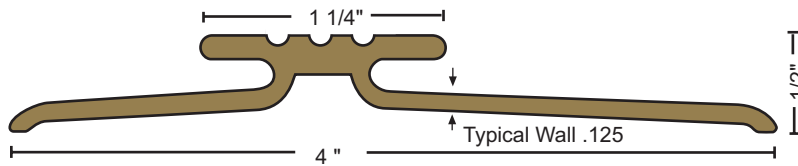

442BR 2.01 lbs./ft.

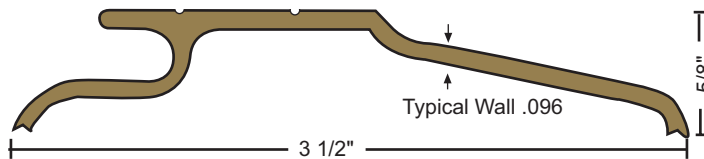

473BR 1.54 lbs./ft.

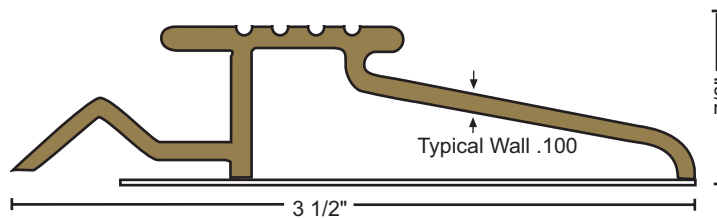

483BR 1.80 lbs./ft. Bronze pan optional - please specify

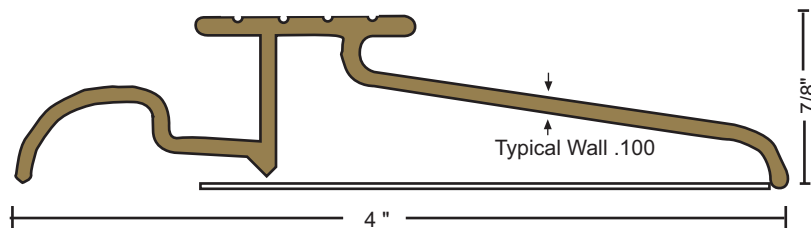

484BR 1.83 lbs./ft. Bronze pan optional - please specify

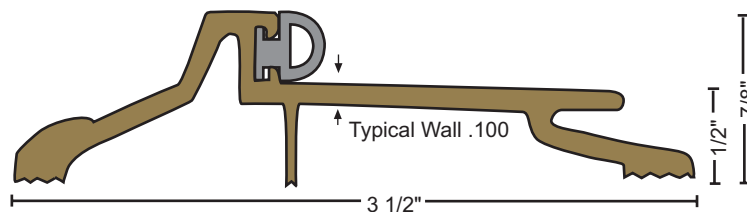

895BR 2.06 lbs./ft. BHMA

Bronze Hook

Supplied Standard with bronze interlocking thresholds:
Furnished with #18 x 7/8" nails

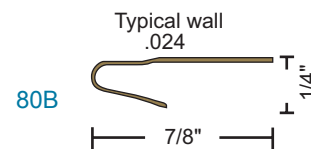

80B

Architectural Bronze satin finish (728) similar to US4.

Optional finishes:

Polished (721), suffix "POL"

Dark oxidized oil rubbed (722)

similar to US10B, suffix "DKB"

Slip-resistant, suffix "SIA"

FASTENERS

#10 X 1-1/2" solid brass wood screws furnished. Antique bronze finish screws provided with dark bronze thresholds.



BUMPER SEAL

Seals against the door providing weather resistance

Vinyl ("V") supplied unless other material specified

Options:

NGP-TPV ("N")

Silicone ("S")

Pile ("P")

Architectural Bronze Custom Thresholds

All products this page



Choose from various height and width components to build custom thresholds to meet special job requirements. See the custom fabricated threshold example illustrated on page T4. For assistance contact our tech support team.

Select the proper height edge components. Select the appropriate center plates to construct the width needed. Plates may be butted together or ripped to make specific widths. Support joints and wider spans with bar supports.

Threshold assembly plates may be used fluted or smooth side up. Slip-resistant SIA finish can be applied to all parts.

Threshold assembly components may be ordered separately for field assembly or welded into one piece units in our custom fabrication shop. They are supplied undrilled unless a template is provided. Ripping and beveling options are available. All custom fabricated assemblies have a tolerance of +/- 1/16".

If a welded assembly is desired, specify "welded".

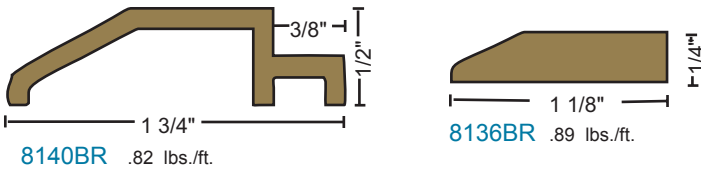

Architectural Bronze satin finish (728) similar to US4.

Optional finishes:

Polished (721), suffix "POL"

Dark oxidized oil rubbed (722)

similar to US10B, suffix "DKB"

Slip-resistant, suffix "SIA"

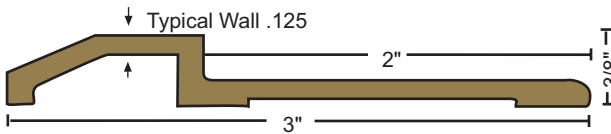

8139BR 1.25 lbs./ft.

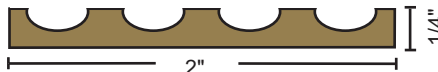

8142BR 1.30 lbs./ft.

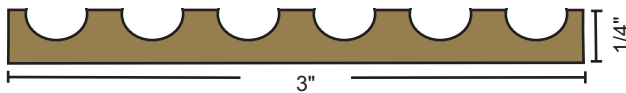

8143BR 2.07 lbs./ft.

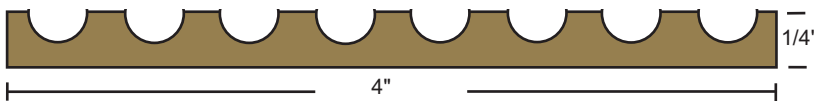

8144BR 2.88 lbs./ft.

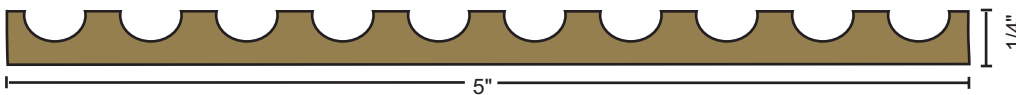

8145BR 3.70 lbs./ft.



8146BR 4.25 lbs./ft.

Bar Supports

used as support under threshold assemblies

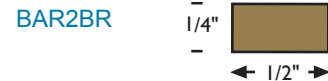
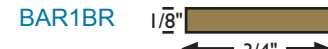



Threshold Fasteners

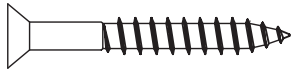

#10 x 1 1/2" Phillips Flat Head Wood Screw
Use 1/8" Drill bit



Phillips Head
Top View



Spanner Head
Top View



Torx Security
Top View



#12 x 1 1/2" Phillips Flat Head Wood Screw
Use 9/64" Drill bit
Also #12 x 1"

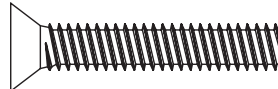

#1/4-20 x 1 1/2" Phillips Flat Head
Machine Screw



#1/4-20 Expansion Anchor
Carbon Steel
Use 3/8" Drill bit

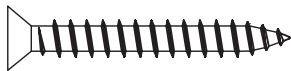

#10 x 1 1/2" Phillips Flat Head Stainless Steel
Sheet Metal Screw
Use 1/8" Drill bit
Also #10 x 1", #10 x 2", #10 x 2 1/2", #10 x 3"



#10-24 x 1 1/2" Phillips Flat Head
Machine Screw
Also #10-24 x 3/4", #10-24 x 1"



#10-24 Lead Anchor
Use 3/8" Drill bit and
Powers seating tool



#12 x 1 1/2" Phillips Flat Head
Sheet Metal Screw
Use 9/64" Drill bit
Also: #12 x 1"

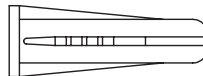

Plastic Anchor Various Sizes
Use Drill Size = Anchor Size



Lead Expansion Shield
4% Antimonial Lead
Use 5/16" Drill bit



#6 x 3/4" Phillips Flat Head Self-tapping
Machine Screw
Use 3/32" Drill bit

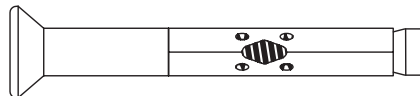

#1/4-20 Phillips Combo Flat Head Machine
Screw/Anchor
Use 1/4" Drill bit

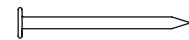

#18 x 7/8" Nail for use with 80B
Hook Strip

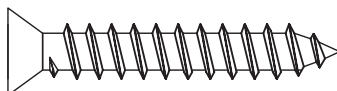

Hilti Kwik-Con II Torx Head Screw, Use Hilti
TKC large concrete bit SDS 1/4" Tough
Carbide

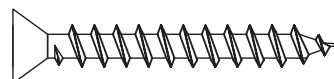

Tap-Con type Phillips Head Screw
Use 5/32" Drill bit