

Securitron® AQL Series Intelligent Power Systems

ASSA ABLOY

Installation Instructions

Experience a safer
and more open world

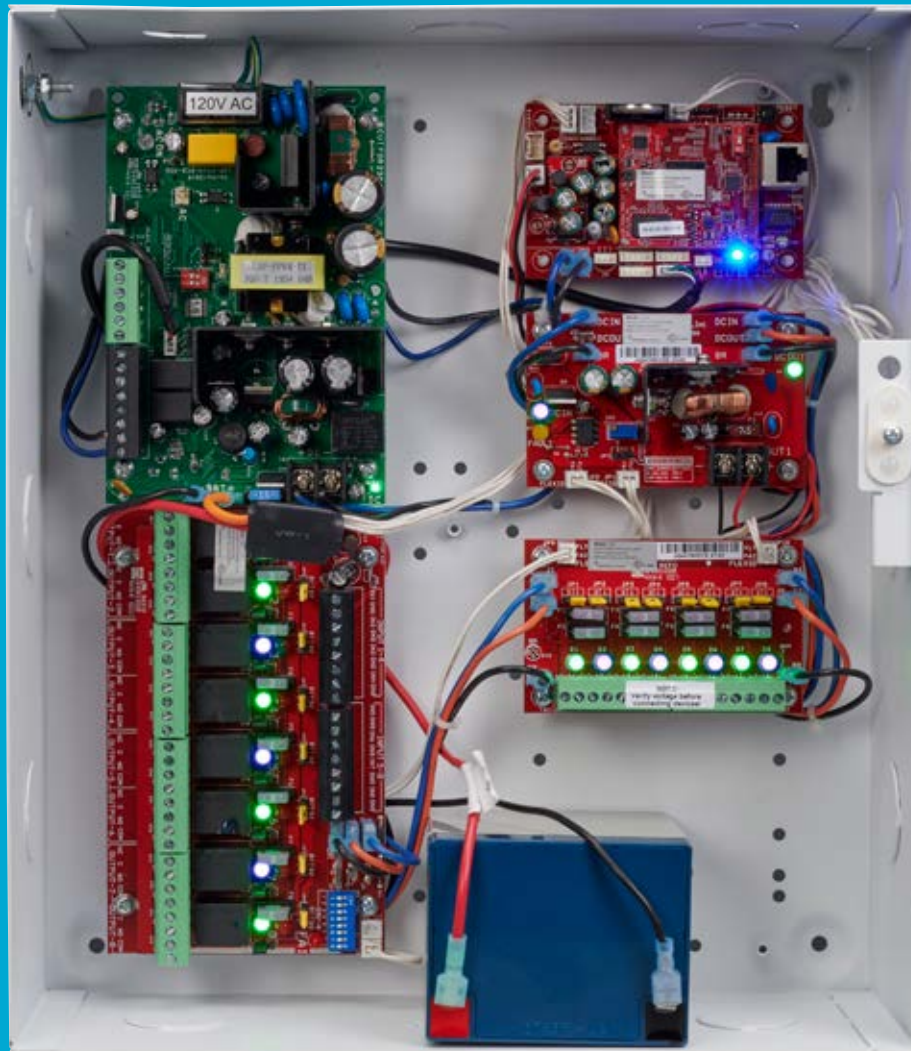

Product Pages

Securitron AQL4, 6, 102/104.....	4
Securitron D8	10
Securitron R8	11
Securitron B100	14
Securitron Netlink	17



Symbol Definitions

The following symbols are used throughout this manual:



Shock Hazards within the enclosure. Service should only be performed by qualified service personnel.



Important Information intended to help the installer avoid personal injury or property damage.

Warnings



Installation and service should be performed only by qualified service personnel and should conform to all local codes.



To reduce the risk of electric shock or fire, do not expose this equipment to rain or moisture.



Replace fuses only with the same type and rating as indicated in the specifications section of this manual.



This equipment shall be installed in a manner which prevents unintentional operation by employees, cleaning personnel, or others working in the premises, by falling objects, customers, building vibration, or similar causes.



This equipment is not intended for use within the patient care areas of a Health Care Facility.



To prevent impaired operation, ensure that all wiring is routed and secured to prevent accidental open or short circuit conditions.



The system and any batteries (if used) should be tested at least once per year to ensure proper operation.



Batteries (if used) should be maintained at an ambient temperature of between 32 and 120 degrees Fahrenheit (0-49 Celsius) or premature loss of battery power could occur.



Test and verify output voltage before connecting the load.

FCC Information

This equipment has been tested and found to comply with the limits for a Class A digital device, pursuant to Part 15 of the FCC Rules and ICES-003. These limits are designed to provide reasonable protection against harmful interference when the equipment is operated in a commercial environment. This equipment generates, uses, and can radiate radio frequency energy and, if not installed and used in accordance with the instruction manual, may cause harmful interference to radio communications. Operation of this equipment in a residential area is likely to cause harmful interference in which case the user will be required to correct the interference at his own expense.

Conventions Used Within this Manual

Positional information (e.g. top, bottom, up, down, left, right, etc.) is referenced with the board or enclosure in the orientation shown in the illustrations in this manual.

General Applications

- 1 The power supply must be installed within the protected area.
- 2 The LifeSafety Power Model EB-80 must be used to house the required battery(ies) when capacities of 40 to 80 Ah are required. The EB-80 shall be mounted within 6 ft of the power supply and the wiring enclosed in conduit.
- 3 Connections to the SYS FLT, AC FLT, and FAI inputs shall be completed within the same room, not exceeding a length of 3 m.
- 4 Do not connect equipment to an AC power source that is controlled by a switch.
- 5 The power supplies shall be mounted in a UL Listed enclosure.
- 6 Trouble contacts shall be monitored by a listed alarm system.

The following sections cover specific requirements based on application:

UL1076, Proprietary Burglar Alarm Applications

- The Securitron tamper switch must be employed to monitor the power supply.
- To achieve 4 hours of standby at full load current, 80 Ah min. battery capacity is required for the Securitron AQL102 or Securitron AQL104. To achieve 4 hours of standby at full load current, 40Ah min. battery capacity is required for the Securitron AQL4 and Securitron AQL6.

S319, Access Control Applications

- The Securitron tamper switch must be employed to monitor the power supply.

For UL Compliance

- Any locking device shall be configured for fail safe operation upon occurrence of an alarm as shown in Activation with a Normally Closed Relay Contact in page 3, FAI Input Usage.

FAI Input Usage

The Fire Alarm Input (FAI) is used to unlock doors during a fire alarm condition. The FAI input will accept various activation methods and must be wired as shown below.

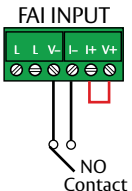
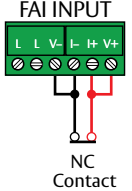
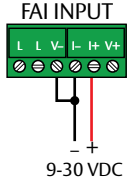
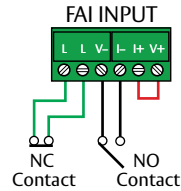
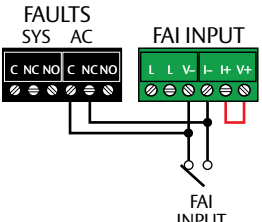
	<h3>Activation with a Normally Open Relay Contact</h3> <p>FAI Activates when the NO contact CLOSES. FAI Deactivates when the NO contact OPENS.</p>
	<h3>Activation with a Normally Closed Relay Contact</h3> <p>FAI Activates when the NC contact OPENS. FAI Deactivates when the NC contact CLOSES.</p> <p>NOTE: FAI with a NC contact cannot be tested by removing the terminal strip, as this will remove the jumper wires from V+ and V- as well. To test, remove one wire going to the NC Contact.</p>
	<h3>Activation with a Voltage Input</h3> <p>FAI Activates when voltage is APPLIED in the correct polarity. FAI Deactivates when voltage is REMOVED.</p>
	<h3>Latching the FAI Input</h3> <p>Latching of the FAI Input is achieved by placing a NC contact across the two 'L' terminals. The FAI may be activated by any of the methods listed. FAI Deactivates when the input is deactivated AND the NC Latching contact is momentarily OPENED.</p> <p><i>Example – NO Contact activation with latching</i></p> <p>FAI Activates when the NO contact CLOSES. FAI Deactivates when the NO contact OPENS AND the NC contact momentarily OPENS.</p>
	<h3>FAI Activation with a Normally Open Relay Contact and Securitron AQL AC Fault Lock Over Ride</h3> <p>FAI Activates either, when the Fire Alarm NO contact CLOSES, or when the AC Fault NC contact CLOSES.</p> <p>FAI Deactivates either, when the Fire Alarm NO contact OPENS, or when the Securitron AQL AC Fault NC contact OPENS.</p>

Tamper Switch Wiring

Securitron AQL DC systems with an enclosure may include a normally closed tamper switch for monitoring by the host panel.

The tamper switch can either be brought into a dedicated input in the panel (see the panel's instructions), to the Event 1 input of a Netlink Network Module (See page 21), or the tamper switch may be series connected into the System Fault relay in the Securitron AQL supply as shown in the illustration.

Any UL1076 installation must use the tamper switch to indicate the opening or removal of the front door of the enclosure.

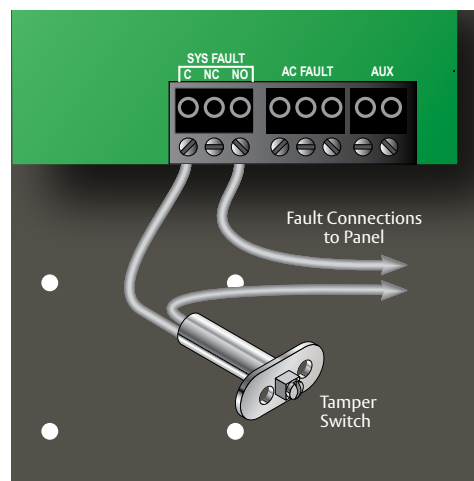

Securitron® AQL4, 6, 102/104 Power Supply Boards

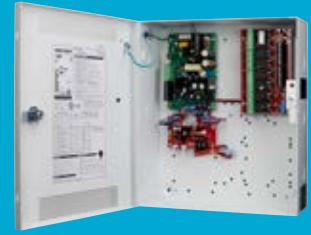

Specifications

Certifications

- UL 294 Listed
- UL 603 Listed
- UL 1076 Listed
- ULC-S318 Listed
- ULC-S319 Listed
- CSA C22.2 #107.1
- RoHS Compliant

Electrical

- Up to 91% efficiency

Environmental

- Operating Temperature: 32° to 120°F [0° to 49°C]

		Securitron AQL4	Securitron AQL6	Securitron AQL102	Securitron AQL104
AC Input	Voltage	120 VAC or 230 VA at 50 – 60Hz			
	Current	1.8 A max	3.7 A max	3 A	5.7 A
Standby	Current	80 mA	150 mA	110 mA	160 mA
DC Output at 12 V Setting <i>(Auxiliary power-limited output rated at 1.5 A. Total current must not exceed max current)</i>	Voltage	11.3 – 12.0 V	11.2 – 12.0 V	11.3 – 12.0 V	
	Max Current	4 A	6 A	10 A	
	Ripple & Noise	120 mV	120 mV	120 mV	
	Regulation	±2%	±2%	±2%	
	Efficiency <small>(120 VAC 60 Hz In, Full Load, No Batt)</small>	82%	88%	89%	
Auxiliary Output (12 V)	Current	1.5 A max	1.5 A max	1.5 A max	
DC Output at 24 V Setting <i>(Auxiliary power-limited output rated at 1.5 A. Total current must not exceed max current)</i>	Voltage	23.5 – 24.0	23.2 – 24.0		23.4 – 25.0 V
	Max Current	3 A	6 A		10 A
	Ripple & Noise	240 mV	240 mV		240 mV
	Regulation	±2%	±2%		±2%
	Efficiency <small>(120 VAC 60 Hz In, Full Load, No Batt)</small>	83%	85%		91%
Auxiliary Output (24 V)	Current	1.5 A max	1.5 A max		1.5 A max
Battery	Size & Type	4 – 40 AH Lead Acid or Gel Cell	4 – 80 AH Lead Acid or Gel Cell	4 – 80 AH Lead Acid or Gel Cell	4 – 80 AH Lead Acid or Gel Cell
	Charge Current	1 A (±10%) maximum adjustable via DIP switch. 1.0 A high setting, 0.5 A low setting.	1.6 A (±10%) maximum adjustable via DIP switch. 1.6 A high setting, 0.8 A low setting.	1.6 A (±10%) max Charger current is 1.6 A max for high setting, 0.8 A max for low setting.	1.6 A (±10%) max Charger current is 1.6 A max for high setting, 0.8 A max for low setting.
	Low battery disconnect to prevent deep discharge	70% of nominal battery voltage			
Fuse Rating	Battery	ATM 15 A			
BTU Output	BTU/Hr	34 – 41	44 – 62	55	92
Fault Setpoints	Low AC	95 V (±6%)			
	Output Voltage	±10% of nominal			
Fault Relay Contacts	AC FLT				
	SYS FLT	1 A at 24 VDC			
Board Size		6"L x 4"W x 2.5"H [152.4mm x 101.6mm x 63.5mm]	8.25"L x 5.5"W x 2.5"H [209.55mm x 139.7mm x 63.5mm]	8.25"L x 5.5"W x 2.5"H [209.55mm x 139.7mm x 63.5mm]	8.25"L x 5.5"W x 2.5"H [209.55mm x 139.7mm x 63.5mm]
Weight		.75 lbs	1.0 lbs	1.5 lbs	1.5 lbs
Enclosure Size		14"H x 12"W x 4.5"D [355.6mm x 304.8mm x 114.3mm]			
Weight		14 lbs			

Mounting Power Boards to the Enclosure

Mounting a Securitron Intelligent Power Board to an enclosure is via the four snap-in standoffs supplied.

- 1 Locate the appropriate mounting holes in the enclosure and snap the standoffs into the holes.
- 2 Align the board mounting holes with the standoffs (be sure the PC board is properly oriented) and snap the board onto the standoffs.



Mounting an Enclosure to a Wall

Use the following procedure when mounting a wall-mount enclosure.

- 1 (Optional) Remove the enclosure's cover.
- 2 Locate the top keyhole mounting holes in the back of the enclosure.
- 3 Mark and pre-drill the locations for the keyholes in the mounting surface.
- 4 Partially install two fasteners appropriate for the surface on which the enclosure is being installed. Leave the heads of the fasteners approximately 1/4" out from the surface. Minimum fastener size should be #10 or larger.
- 5 Hang the enclosure on the two fasteners and mark the locations of the remaining mounting holes.
- 6 Remove the enclosure and pre-drill the locations for the remaining mounting holes.
- 7 Re-hang the enclosure on the top mounting fasteners, start the remaining fasteners and tighten all fasteners.
- 8 Reinstall the enclosure's cover, if removed in step 1.



It is the installer's responsibility to determine the appropriate fastening system for use with the surface the enclosure is being mounted to.

For UL1076 applications, after installation is complete, the installer must install the two supplied 1" long screws to the edge of the enclosure's cover for additional security.

Securitron AQL4

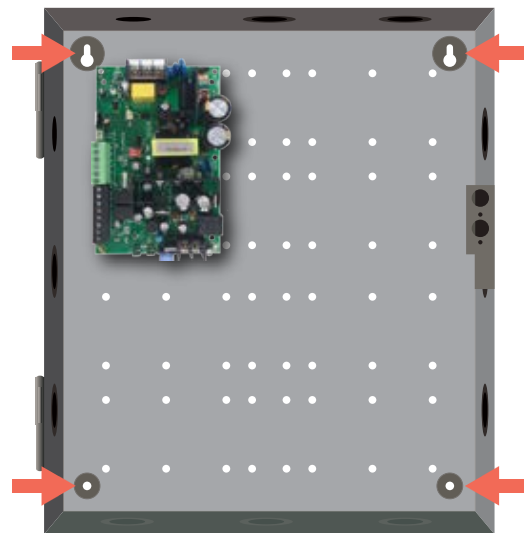

Securitron AQL6, 102, 104

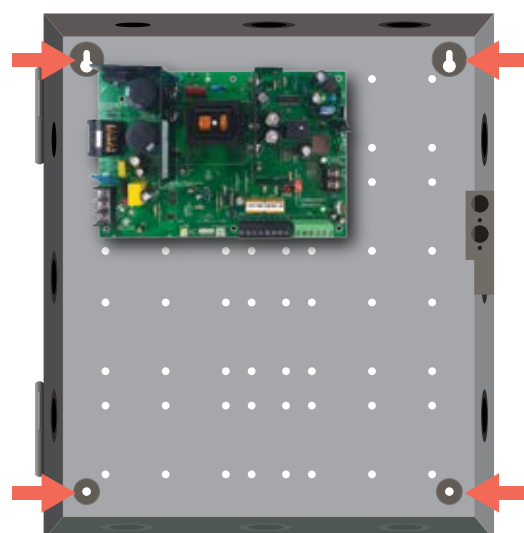

Typical Installation & Wire Routing

Actual configuration and wire routing will vary based on the components installed in your system.

The following guidelines should be followed for installation:

- Class 2 Power limited wiring must be separated from nonpower limited wiring by a minimum of 1/4" and must use separate knockouts.
- Any wiring passing through knockouts in the bottom or top surfaces of the enclosure must be enclosed in rigid or flexible metal conduit.
- **Canadian Installations** – For permanently connected equipment, a readily accessible disconnect device shall be incorporated external to the equipment. Output circuits not connected to removable terminal strips shall also utilize a readily accessible disconnect device.

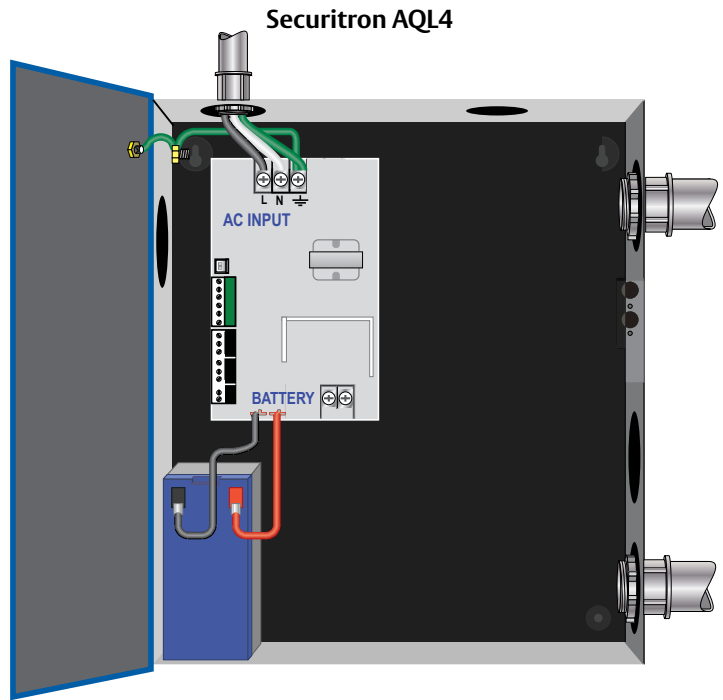

Securitron AQL6, 102, 104
(Typical installation)

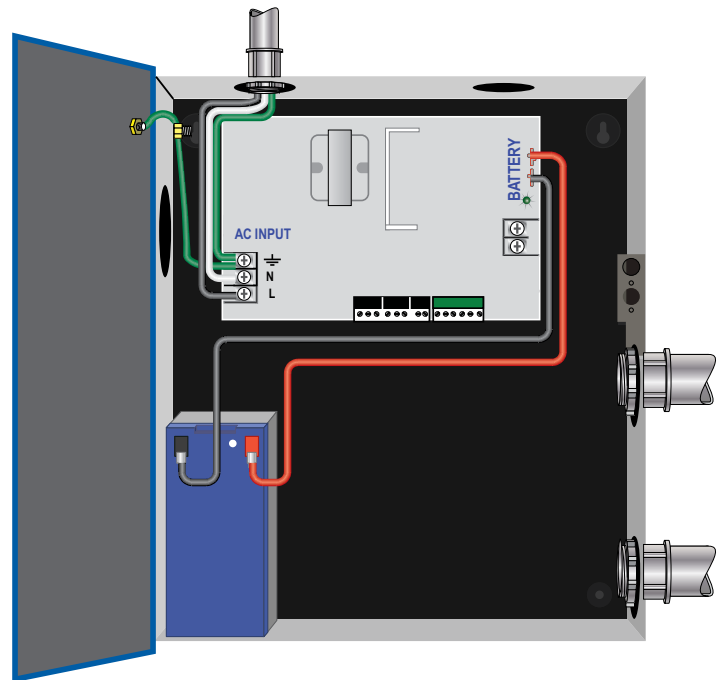

Securitron AQL4 Power Supply Overview

1 AC Voltage Select Jumper – Leave INTACT for 120 V input. CUT for 230 V input.

! Failure to cut this jumper when using the Securitron AQL with a 230 VAC input will result in damage to the system.

2 AC Input primary AC connection.

3 AC On LED (GREEN) – Indicates a valid AC input voltage is present. Missing AC is indicated by this LED extinguishing.

! **WARNING:** Always confirm the absence of AC power with a meter before servicing to prevent electric shock.

4 Voltage Selection Jumper – Selects the output voltage between 12 V and 24 VDC.

! **WARNING:** Remove AC input power before changing the voltage select switch to avoid damaging the power supply or connected equipment.

5 FAI LED (RED) – Indicates activation of the Fire Alarm Input.

6 FlexIO Connector – Supplies FAI status to any accessory boards. Receives fault signal from accessory boards.

7 FAI & Charge Current Configuration Switches

SWITCH 1 FAI Selection	SWITCH 2 Charge Current
OFF = Constant Output	OFF = High Charge Current
ON = Output switches on FAI	ON = Low Charge Current

8 System Fault Contact – Contact labeling is adjacent to the terminals and shown in the unpowered (FAULT) condition.

9 AC Fault Contact – Contact labeling is adjacent to the terminals and shown in the unpowered (FAULT) condition. AC fault is indicated on a missing AC Input voltage.

10 Auxiliary Voltage – A fixed Class 2 DC output.

11 FAI Input – The input from the FACP. Can be wired to accept a NO, NC, Open Collector, or Voltage input.

12 Battery Terminal Connection – For the optional battery backup. Battery set voltage must match the DC output voltage setting.

13 Main DC Output – Of the power supply. The output can either be constant or switched based on the configuration setting of Switch 1.

! **NOTE:** The DC ON LED will be green with voltage present, if set to 12 VDC or blue if set to 24 VDC.

14 DataLink Connection – This connector allows optional programming and monitoring of the Securitron AQL power supply via an optional NetLink network module. See the instructions for the Netlink module for more information, page 17.

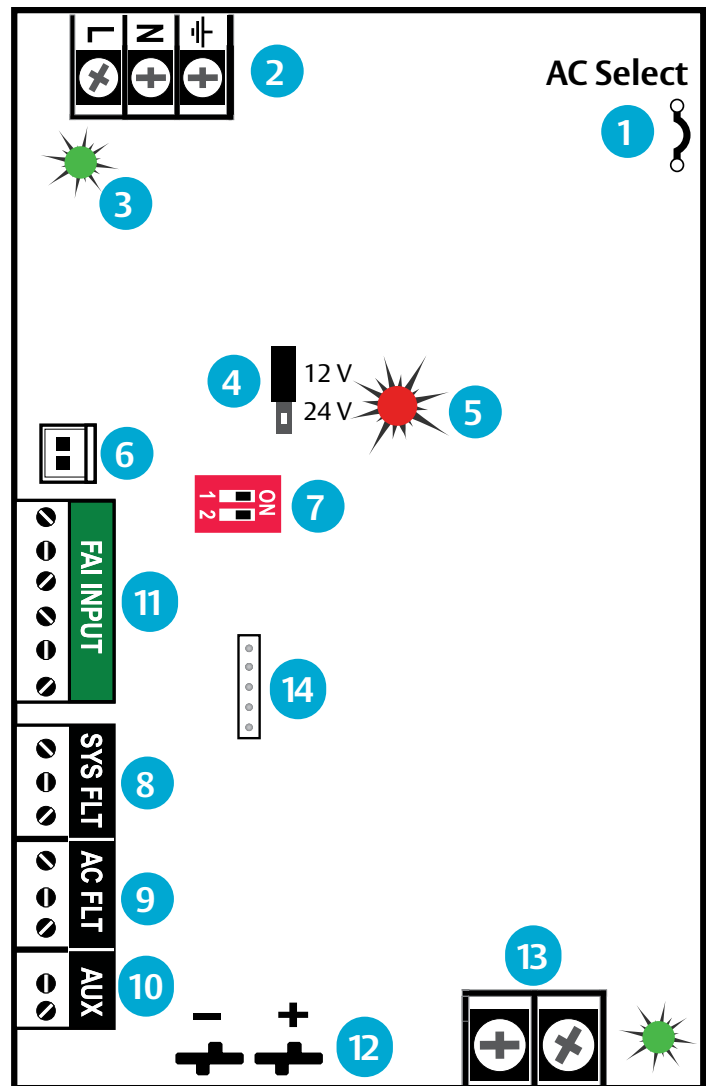

! Observe battery polarity or damage may result

Securitron AQL6 Power Supply Overview

This guide gives the basic information needed to install a system containing a single Securitron AQL Power supply for most applications.

- 1 AC Input Voltage Selection** – Leave INTACT for 120 V input. CUT for 230 V input.

! Failure to cut this jumper when using the Securitron AQL with a 230VAC input will result in damage to the system.

- 2 AC Input** – The primary AC connection. Cut JP1 for 230 VAC input.

- 3 AC ON LED (GREEN)** – Indicates a valid AC input voltage is present. Missing AC is indicated by this LED extinguishing.

! Always confirm the absence of AC power with a meter before servicing to prevent electric shock.

- 4 FAI LED (RED)** – Indicates activation of the Fire Alarm Input.

- 5 Charge Current / Main Output FAI Configuration Switches**

SWITCH 1 FAI Selection	SWITCH 2 Charge Current
OFF = Constant Output	OFF = High Charge Current
ON = Output switches on FAI	ON = Low Charge Current

- 6 FLEX IO Connector** – Supplies FAI status to any accessory boards. Receives fault signal from accessory boards.

- 7 System Fault Contact** – Contact labeling is adjacent to the terminals and shown in the unpowered (FAULT) condition.

- 8 AC Fault Contact** – Contact labeling is adjacent to the terminals and shown in the unpowered (FAULT) condition. AC fault is indicated on a missing AC Input voltage.

- 9 AUX Voltage** – The auxiliary voltage is a fixed Class 2 Power Limited DC output.

- 10 FAI Input** – The input from the FACP. Can be wired to accept a NO, NC, Open Collector, or Voltage input.

- 11 Main Output** – This is the main DC output of the power supply. The output can either be constant or switched based on the configuration setting of switch 1 (*see number 5 on this page*). The DC ON LED will light: GREEN 12 V | BLUE 24 V.

- 12 Battery Terminal Connection** – The connection for the optional backup battery. Battery set voltage must match the DC output voltage setting.

- 13 12/24 V Selection Jumper** – This selects the output voltage between 12 V and 24 V DC. The Securitron AQL Power supply must be completely powered down before changing this setting. Voltage markings are printed on the PC Board adjacent to the selector.

! Remove AC input power before changing the voltage select switch to avoid damaging the power supply or connected equipment.

- 14 DataLink Connection** – This connector allows optional programming and monitoring of the Securitron AQL power supply via an optional NetLink network module. *See the instructions for the Netlink module for more information.*

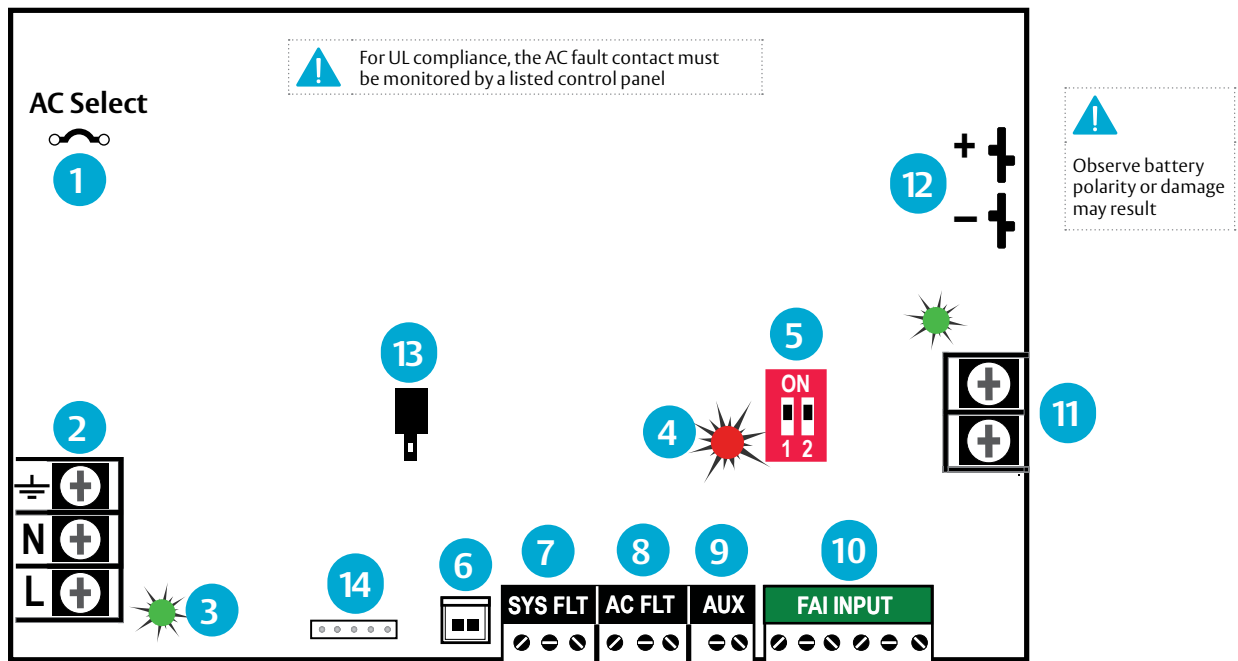

Securitron AQL102/104 Power Supply Overview

This guide gives the basic information needed to install a system containing a single Securitron AQL Power supply for most applications.

- 1 AC Input Voltage Selection** – Leave INTACT for 120 V input. CUT for 230 V input.

 Failure to cut this jumper when using the Securitron AQL with a 230 VAC input will result in damage to the system.

- 2 AC Input** – The primary AC connection. Cut JP1 for 230 VAC input.

- 3 AC ON LED (GREEN)** – Indicates a valid AC input voltage is present. Missing AC is indicated by this LED extinguishing.

 Always confirm the absence of AC power with a meter before servicing to prevent electric shock.

- 4 FAI LED (RED)** – Indicates activation of the Fire Alarm Input.

- 5 Charge Current / Main Output FAI Configuration Switches**

SWITCH 1 FAI Selection	SWITCH 2 Charge Current
OFF = Constant Output	OFF = High Charge Current
ON = Output switches on FAI	ON = Low Charge Current

- 6 FLEX IO Connector** – Supplies FAI status to any accessory boards. Receives fault signal from accessory boards.

- 7 System Fault Contact** – Contact labeling is adjacent to the terminals and shown in the unpowered (FAULT) condition.

- 8 AC Fault Contact** – Contact labeling is adjacent to the terminals and shown in the unpowered (FAULT) condition. AC fault is indicated on a missing AC Input voltage.

- 9 AUX Voltage** – The auxiliary voltage is a fixed Class 2 Power Limited DC output.

- 10 FAI Input** – The input from the FACP. Can be wired to accept a NO, NC, Open Collector, or Voltage input.

- 11 Main Output** – This is the main DC output of the power supply. The output can either be constant or switched based on the configuration setting of switch 1 (see number 5 on this page). The DC ON LED will light: GREEN 12 V | BLUE 24 V.

- 12 Battery Terminal Connection** – The connection for the optional backup battery. Battery set voltage must match the DC output voltage setting.

Power Supply Fixed Voltage:

- Securitron AQL102: 12 V / 10 Amps
- Securitron AQL104: 24 V / 10 Amps

- 13 DataLink Connection** – This connector allows optional programming and monitoring of the Securitron AQL power supply via an optional NetLink network module. See the instructions for the Netlink module for more information.

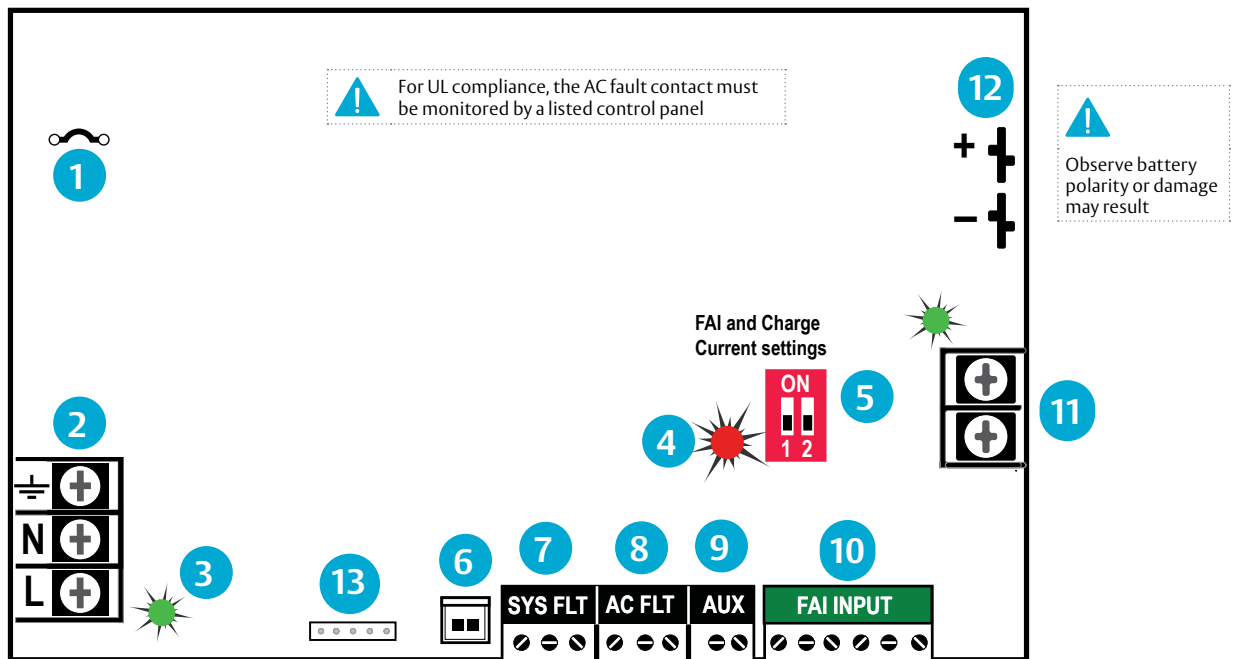

Securitron® D8/D8P Power Distribution Module



Specifications

Certifications

- UL 294 Listed
- UL 603 Listed
- UL 1076 Listed
- ULC-S318 Listed
- ULC-S319 Listed
- CSA C22.2 #107.1
- RoHS Compliant
- CSFM Approved
- FCC Part 15, Subpart B

Electrical

- 8 continuous outputs
- **Input**
 - » Voltage: 5-24 VDC nominal
 - » Current: 12 A maximum
 - » Standby Current: 65 mA
- **Output**
 - » Voltage: same as input
 - » D8 Current: 3 A resistive fuse
3 A ATM automotive style
 - » D8P Current: 2.5 A resistive
(Class 2 Power Ltd)

Shipping Weight

- .15 lbs

Dimensions

- 4" x 2.5" x 1"
[102mm x 64mm x 25mm]

Overview

- 1 FlexIO Connectors** – These connectors pass the FlexIO buss through the D8 to other accessory boards in the system.
- 2 B1 Connectors (J1 & J4)** – These fastons are for connection to the B1 voltage buss in the system. The voltage on the B1 buss comes from the main output of an Securitron AQL power supply. This voltage will be directed to any outputs whose Output Selection Jumper is set in the B1 position.
- 3 B2 Connectors (J3 & J5)** – These fastons are for connection to the B2 voltage buss in the system. The voltage on the B2 buss comes from the main output of an Securitron AQL power supply in a dual voltage system. This voltage will be directed to any outputs whose Output Selection Jumper is set in the B2 position. If the D8 is being used in a single voltage system, these fastons can be left unused.
- 4 BR Connectors (J2 & J6)** – The DC Common buss in the system. All boards in the system must have their BR fastons wired together for proper operation.
- 5 Output Selection Jumpers (JP1 – JP8)** – These jumpers select which voltage buss input is selected for the output. Jumper numbers correspond with the zone number (e.g. JP1 is the jumper for OUT1). Possible settings are as follows:
 - **Position 2 (LEFT)** – B2 Buss
 - **Position 1 (RIGHT)** – B1 Buss
 - **Removed** – Disable Output
- 6 Output Fuses (F1 – D8)** – When using the fused version of the D8, these are the fuses for each zone output. Fuse numbers correspond with the zone number (e.g. F1 is the fuse for OUT1). When using the PTC version of the D8, the fuse will be replaced with a soldered-in PTC.

- 7 Output LEDs (D1 – D8)** (Dual Color – GREEN/BLUE) – These LEDs indicate the availability of voltage on a zone's output. When voltage is available on the output terminals, the LED is lit. GREEN 12 VDC | BLUE 24 VDC. LED numbers correspond with the zone number (e.g. D1 is the LED for OUT1).
- 8 Zone Outputs (Out1 – Out8)** – These are the zone output terminal strips. These terminal strips are removable and accept wire sizes from AWG 14 – AWG 22. The terminals are labeled on the PC board underneath the terminal strip.

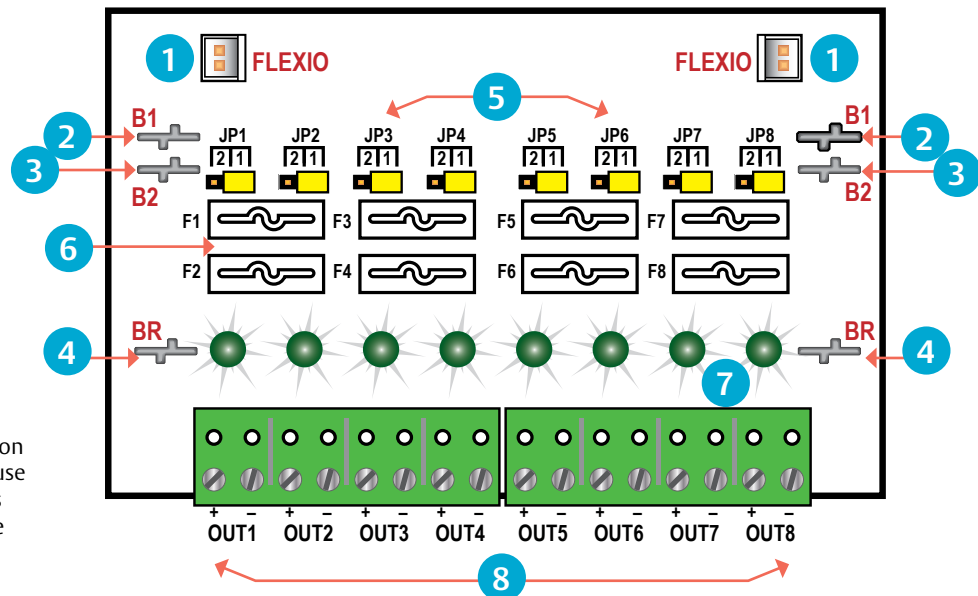
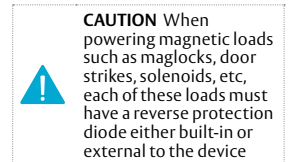

Input Wiring

Each input on the R8 has an "IN" terminal and a "GND" terminal.

- When using a NO relay contact to activate the input, the contact is placed across these terminals.
- To use a DC ground or an open collector (transistor) as an input, connect the ground/open collector to the "IN" terminal to activate the input. Note that the input source must be common grounded with the R8 board's power source.

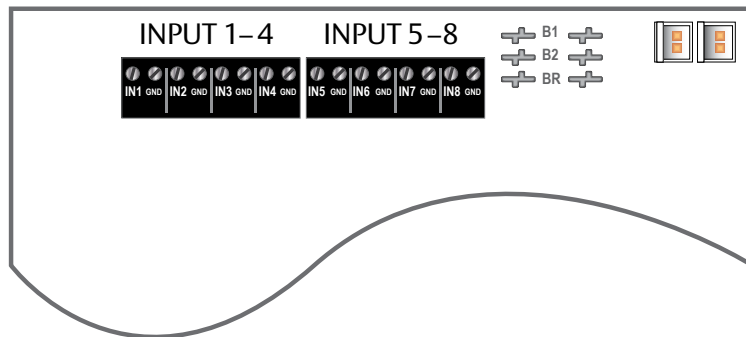

Output Wiring

- Each output on the R8 has "NC", "C", "NO", and "COM" terminals.
- When set for a dry contact output, the C, NC, and NO terminals may be used as any relay would. C to NC will have a connection when the red LED for the zone is not lit. C to NO will have a connection when the red LED is lit.

NOTE: To set the output as a dry contact, the yellow and black jumpers for the zone must be removed and the output diodes must be cut.

- When set for a voltage output, the terminal use is as follows:
 - › **COM** – This is the Negative DC Common for the device being powered
 - › **C** – This terminal always has positive voltage, regardless of the relay state. This terminal may be used to power auxiliary devices such as REX or readers.
 - › **NC** – This output has positive voltage when the relay is NOT ACTIVE. This terminal is used for FAIL SAFE locks
 - › **NO** – This output has positive voltage when the relay is ACTIVE. This terminal is used for FAIL SECURE locks

NOTE: Other Securitron Power Boards (not part of AQL series) use C as a negative DC common.

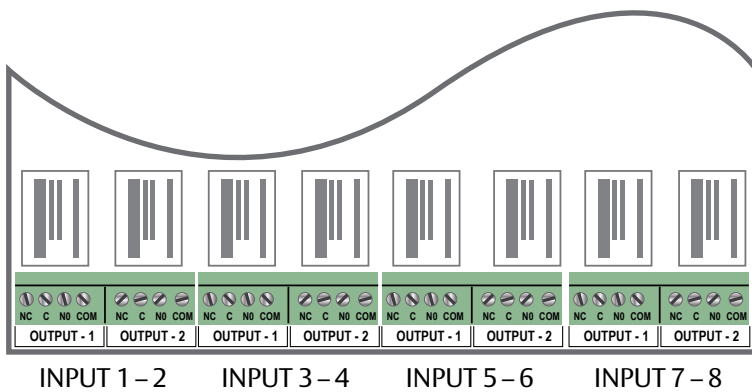

Power Control Dry Contact Output

The outputs of the R8 have built-in reverse protection diodes. If a delay in lock release is present or if the zone is being used as a dry contact output, the diode from that zone may be removed from the circuit as shown below.

NOTE: Only remove the diodes from outputs requiring their removal

Diode Removal

The diodes on the R8 are on the top side of the board between the output terminals and the edge of the board. To remove the diode from the output circuit, simply cut the exposed diode lead for the desired output zone - leave the diode body soldered to the pcb.

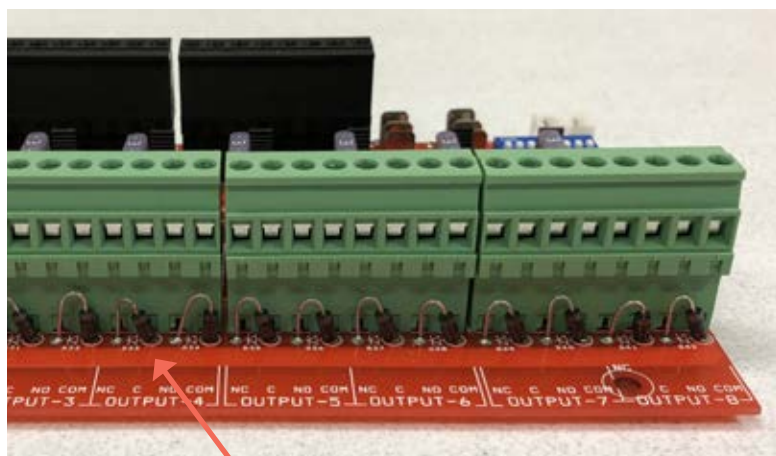

Securitron B100 Secondary Voltage Module



Description

The Securitron B100 provides an additional voltage in a Securitron AQL power system. This voltage can either be accessed directly via the Securitron B100's terminals or through other Securitron AQL Accessory Boards. The Securitron B100's input is typically supplied by the B1 buss in the system, allowing the Securitron AQL's battery set to back up the Securitron B100's output voltage without the need for a second battery set. Output settings for the Securitron B100 include a fixed 12 V setting and an adjustable setting of 5 to 18 V. Multiple Securitron B100s can be added to a system for virtually unlimited voltage combinations.

Specifications

Certifications

- UL 294 Listed
- UL 603 Listed
- UL 1076 Listed
- ULC-S318 Listed
- ULC-S319 Listed
- CSA C22.2 #107.1
- RoHS Compliant
- CSFM Approved
- FCC Part 15, Subpart B

Shipping Weight

- .2 lbs

Dimensions

- 4" x 2.5" x 1.75"
[102 mm x 64 mm x 45 mm]

Electrical

- **Input**
 - » Voltage: 8-25 V (Must be at least 3 V above output voltage setting)
 - » Current: 3.5 A maximum
 - » Standby Current: 35 mA
- **Output**
 - » Voltage: 4.7-23 V
 - » Current: 4 A maximum (Class 2 power limited)
- **Fuse**
 - » 7.5 A ATM automotive style

Overview

1 DC IN Connectors (J1 & J4) – These fastons are the input to the Securitron B100. Either faston may be used as the input. Two connections are provided to allow this voltage to pass through to other accessory boards in the system. This input voltage must always be at least 3 volts above the output voltage setting for the Securitron B100 to maintain its output.

2 DC OUT Connectors (J2 & J5) – These fastons are the output of the Securitron B100 for connection to other accessories in the system. This output may be considered as an equivalent to the main output of an Securitron AQL power supply. Either or both DC OUT fastons may be used in the system.

! Ensure there are no other voltage sources connected to the buss before powering the system or damage WILL occur.

3 BR Connectors (J3 & J6) – The DC Common buss in the system. All boards in the system must have their BR fastons wired together for proper operation.

4 DC IN LED (D1) (BLUE/GREEN) – This LED indicates the availability of voltage on the DC IN Buss. When voltage is available on the buss, the LED is lit. This LED is bi-color and indicates the input voltage as follows: GREEN – 12 V Input | BLUE – 24 V Input

! **NOTE** LED colors are range based. Voltage Less than 13 V will show Green. Voltage above 20V will show Blue. Voltage between 13 and 20 may show either voltage or a combination Green & Blue. Always verify voltage with a voltmeter

5 FAULT LED (D7) (YELLOW) – This LED lights when the Securitron B100 detects a fault condition. This fault condition also transmits to the Securitron AQL power supply. Fault conditions detected include ruptured output fuse, no output, output overload, or output voltage out of regulation.

6 FlexIO Connectors (JP1 & JP2) – These connectors allow the fault status of the Securitron B100 to be transmitted to the Securitron AQL power supply and pass the FlexIO buss on to other accessory boards in the system.

7 Output Voltage Selection (JP3 & VR1) – This jumper selects the output voltage for the Securitron B100 and the potentiometer sets the output voltage when in the adjustable range. In adjustable range, voltage may be set from 5 to 18 VDC.

Possible jumper settings are as follows:

- 12 V Out JP3 Position 1
- Adjustable Output JP3 Position 2

! The VR1 potentiometer will have no effect unless the jumper is set for the adjustable range
NOTE that the input must be at least 3 V above the output voltage setting or the Securitron B100 will display a fault condition. It may be helpful to temporarily set the input power supply to 24 V (Remove load devices first) before setting the Securitron B100 output voltage.

8 DC Output – This is the output terminal strip. This terminal strip is nonremovable and accepts wire sizes from AWG 12 – AWG 22. The terminals are labeled on the PC board by the terminal strip.

9 Output Fuse (F1) – This fuse protects the DC Output terminals. It does not protect the DC OUT faston.

10 DC OUT LED (D4) (GREEN) – This LED indicates the availability of voltage on the DC OUT Buss. When voltage is available on the buss, the LED is lit.

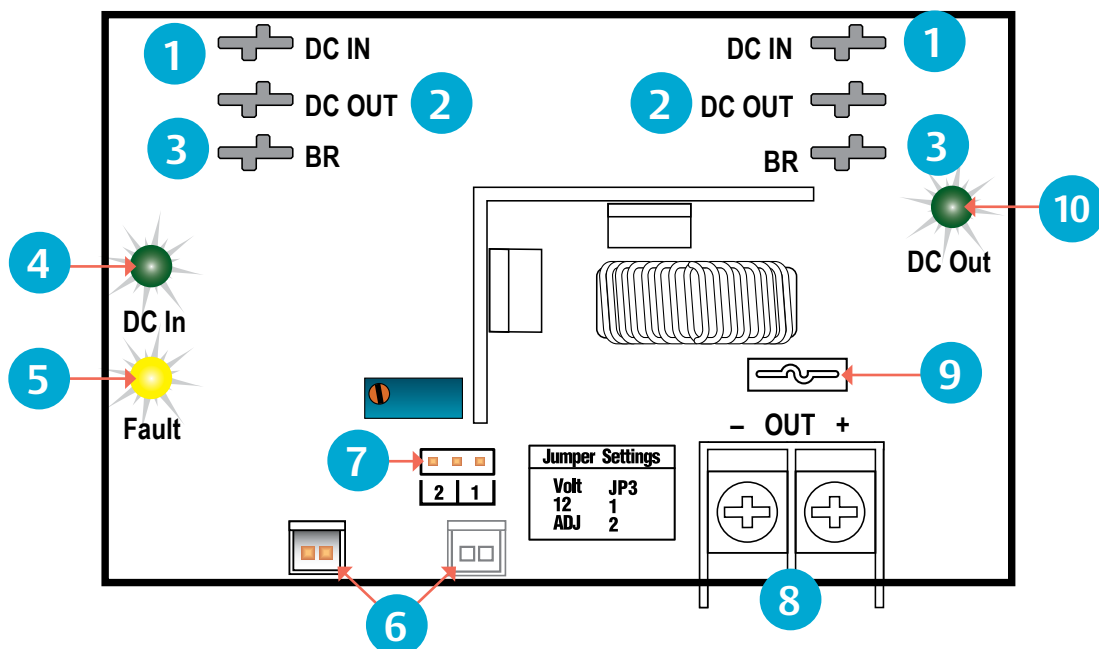

Current Loading

Power drawn from the Securitron B100 subtracts from the power available from the Securitron AQL supplying the Securitron B100. The most accurate way to determine the draw from the Securitron AQL is to calculate the actual power draw and factor in the efficiency of the Securitron B100.

$$PI = PO * 1.15$$

Where:

PI = Input power of the Securitron B100

PO = Output power draw on the Securitron B100

Max Power Available	12V	24V
Securitron AQL4	48 W	72 W
Securitron AQL6	72 W	144 W
Securitron AQL102	120 W	
Securitron AQL104	240 W	

Current Load Examples

Example 1 What size Securitron AQL power supply do you need to create a dual voltage power supply system providing 24 V at 2 A and 12 V at 2 A?

- 1 Determine current load: $12\text{ V} \times 2\text{ A} = 24\text{ W} \times 1.15 = 27\text{ W}$ | $24\text{ V} \times 2\text{ A} = 48\text{ W}$
- 2 $27\text{ W} + 48\text{ W} = 75\text{ W}$ current load
- 3 Find Securitron AQL power supply rating: 144 W for AQL6 | 240 W for AQL104
- 4 Use a Securitron AQL6 or AQL104 to meet the system's power needs

Example 2 An Securitron AQL4 is powering a Securitron B100. The Securitron B100 is set for an output of 12 V and has 3 A total load connected. How much power is available from the Securitron AQL4?

- 1 Determine current load: $12\text{ V} \times 3\text{ A} = 36\text{ W} \times 1.15 = 41\text{ W}$
- 2 Find AQL power supply rating: 48 W for the Securitron AQL4
- 3 Subtract current load from power supply rating: $48\text{ W} - 41\text{ W} = 7\text{ W}$ available from Securitron AQL power supply

Example 3 What size Securitron AQL power supply do you need to create a dual voltage power supply system providing 24 V at 4 A and 5 V at 2 A?

- 1 Determine current load: $5\text{ V} \times 2\text{ A} = 10\text{ W} \times 1.15 = 11\text{ W}$ | $24\text{ V} \times 4\text{ A} = 96\text{ W}$
- 2 $11\text{ W} + 96\text{ W} = 107\text{ W}$ current load
- 3 Find Securitron AQL power supply rating: 144 W for AQL6
- 4 Use a Securitron AQL6 to meet the system's power needs

Connecting the Securitron B100

- Remove all AC and battery power from the Securitron AQL system before adding or replacing a Securitron B100 board.
- Observe polarity of the DCIN and BR Connections or damage to the system could occur.
- The DC In, DC Out, and BR terminals run through the board for daisy chaining and each terminal set is interchangeable from a functional standpoint. Either DC IN may be used, either DC Out may be used or either BR may be used interchangeably.

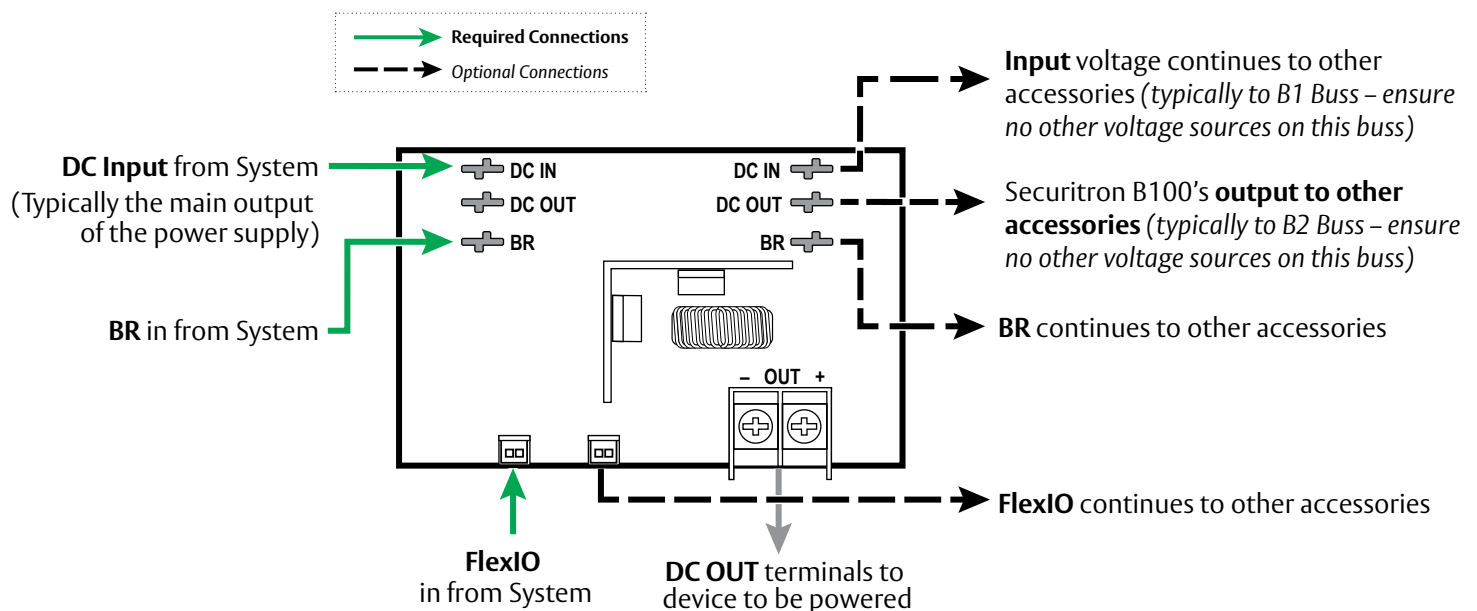

Securitron® Netlink Power Monitoring Module



Product Description

The Securitron Netlink NL4 module is a network appliance which may be used with Securitron AQL power systems to provide remote monitoring of the power system and connected devices. The NL4 provides four ports for connection to Securitron power supply boards.

The Securitron Netlink module monitors power supply system status over a local or wide area network and provides values such as output voltage, fault status, battery voltage, battery charging current, fire alarm status, and temperature. In addition, automated battery tests may be run manually, or scheduled to happen automatically.

Automated alerts may be sent via email or SNMP on any detected fault condition, service due date approaching, battery condition, fire alarm activation, or on a time basis for status updates on regular intervals. A time and date stamped log of the past 1000 events is kept and may be viewed on demand, or immediately on an alert occurrence. When all parameters are in range, the log is updated once per selected interval with a snapshot of current values.

All Securitron Netlink modules provide a voltmeter input, event input (for monitoring devices such as the enclosure tamper switch), and one or two current sensors. Internal temperature is also sensed, and the NL4 also includes a 6 foot external temperature probe for monitoring room temperature.

Specifications

Certifications

- UL 294 Listed
- UL603 Listed
- UL1076 Listed
- ULC-S318 Listed
- ULC-S319 Listed
- CSA C22.2 #205

Shipping Weight

- .25 lbs

Dimensions

- 4" x 2.5" x 1.5"
[101.6mm x 63.5mm x 38.1mm]

Electrical

- **Input**
 - » Operating Voltage: 8 to 30 VDC
 - » Operating Current: 60 mA nominal
- Network Data Rate: 10/100 Mbps
- Voltage Measurement Range: 0 to 30 VDC \pm 3%
- Current Measurement Range: 0 to 20 A \pm 0.1 A + 5% of reading
- **Event**
 - » Input: 9 to 30 VDC
 - » Current: 15 mA Max
- Output 1 & 2 Current: 50 mA maximum

Class 2 power limited wiring must be separated from non-power limited wiring by a minimum of 1/4 inch and must use separate knockouts

The installation and all wiring methods shall be in accordance with ANSI/NFPA70 and all local codes.

For ULC compliance, installation and all wiring methods shall be in accordance with the Canadian Electrical Code, C22.1, Part I, Section 32.

All input/output wiring to the module shall be located within the same room (3 m. max.).

The remote control features have not been investigated by UL.



Manual covers Firmware Rev 8.071-45

Older firmware revisions may not have all features described.

See the latest firmware release notes at

<http://www.lifesafetypower.com/support/software-firmware-downloads>



Resetting the Securitron Netlink

If the user name or password is unknown for a Securitron Netlink board, press and hold the **Reset** button located next to the backup battery for 10 seconds to return these values to default. Pressing the **Reset** button for 30 seconds will also reset the IP address, certificate, and Cipher Suite to default.



Upgrading Securitron Netlink Firmware

The browser history/cache should be cleared after performing the firmware upgrade and before accessing the Securitron Netlink again to prevent any cached pages from giving outdated information.

See page 23 for detailed steps for firmware upgrades

Module Overview

The following are basic Securitron Netlink board descriptions. Refer to the appropriate section for more detailed information.

- 1 C1 and C2 Inputs (J12 & J16)** – These are the connectors for the current sensors. Only NL4 current sensor should be plugged into this connector. The sensors have a range of +/-20 A and are typically used to monitor battery discharge current. *See page 22.*
- 2 Event 1 Input (J14)** – This is the connector for the Event1 input. This input will accept 9-30 VDC to initiate an event alert. This input will only indicate an active or inactive condition and will not measure the voltage level. *See page 21.*
- 3 ADC1 Input (J15)** – This is the Analog to Digital Converter (ADC) input, which acts as a voltmeter. It accepts 0-30 V and is used to measure positive or negative system voltages which are common grounded with the Securitron Netlink board. The ADC cable wiring must be routed away from high voltages. *See page 22.*
- 4 Input V+ & V- (J1 & J3)** – This is the power input for the Securitron Netlink board. This input accepts 8 to 30 VDC ONLY from any power supply.



NOTE: The voltage input of the Securitron Netlink must be connected directly to the main or aux output or to the AUX input of the power supply.

- 5 Ethernet Connection (SK1)** – This is the RJ45 jack for the network connection. The ethernet cable is plugged into this jack. *See page 20.*
- 6 Status LED Indicators (D2, D3, D4)** – These LEDs indicate the status of the Ethernet link to the Securitron Netlink board.
LED Indicator:
 - › **GREEN (LINK)** Lights when Securitron Netlink is connected to a network
 - › **RED (DATA)** Flashes during data transfer
 - › **BLUE (SYS)** Lights when the Securitron Netlink is fully booted up and running. During the bootup process, this LED may flash on and off several times. The Securitron Netlink will not be able to be accessed until this LED lights steady.
- 7 External Temperature Sensor (J18)** – This connector is for the external temperature sensor. *See page 22.*
- 8 Future use (J9)** – This jumper is reserved for future use and should be left OFF.
- 9 Event1 Input Invert Jumper (J8)** – This jumper inverts the action of the Event 1 Input. *See page 21.*
Jumper Position:
 - › **OFF** Event 1 active when voltage is applied
 - › **ON** Event 1 active when voltage is removed
- 10 Backup Battery (BT1)** – This is the coin cell battery for maintaining the clock when all power is removed from the Securitron Netlink. The battery type is CR2032.

- 11 Factory Reset Button (SW1)** – This button resets the User Name, Password, and IP Address settings back to factory default. Typically used when IP and/or login information has been lost. *See page 24 for more information.*
- 12 Device 1 – Device xx (J4, J5, J11, J17)** – Data is passed between the Securitron Netlink board and it's connected devices through these Device serial port links. The NL4 has four serial links to monitor up to four devices (maximum combination of two AQL). AQL must connect to Device 1 and 2 respectively. *See page 20.*
- 13 Control Outputs (J10)** – This connector is for the two control outputs. These outputs are open collector (transistor) low-current outputs for use with RB Relay Boards or other low-current inputs. The Control Output cable wiring must be routed away from high voltages. *See page 22.*
- 14 Enable 100Mbps (J19)** – If present, this jumper enables 100Mbps speed for the network connection.
- 15 Future Use (J20 & J22)** – If present, these jumpers are reserved for future use and should be left OFF.
- 16 Current Sensor – Current Lead 1 (SHORT)** – The short orange lead connects in-line with the current to be measured toward the more negative side of the current flow. Positive current is measured when current flows from Current Lead 2 (Long Lead) to Current Lead 1 (Short Lead). When using to measure battery discharge current, this lead goes to the BAT+ terminal on the power supply. *See page 21.*
- 17 Current Sensor – Current Lead 2 (LONG)** – The long red lead connects in-line with the current to be measured toward the more positive side of the current flow. Positive current is measured when current flows from Current Lead 2 (Long Lead) to Current Lead 1 (Short Lead). When using to measure battery discharge current, this lead goes toward the positive battery terminal. *See page 21.*
- 18 Current Sensor – Data Connector** – This connector connects to the Securitron Netlink board's C1 or C2 input (J12 or J16) to provide the current reading to the Securitron Netlink. *See page 21.*

Diagram 1

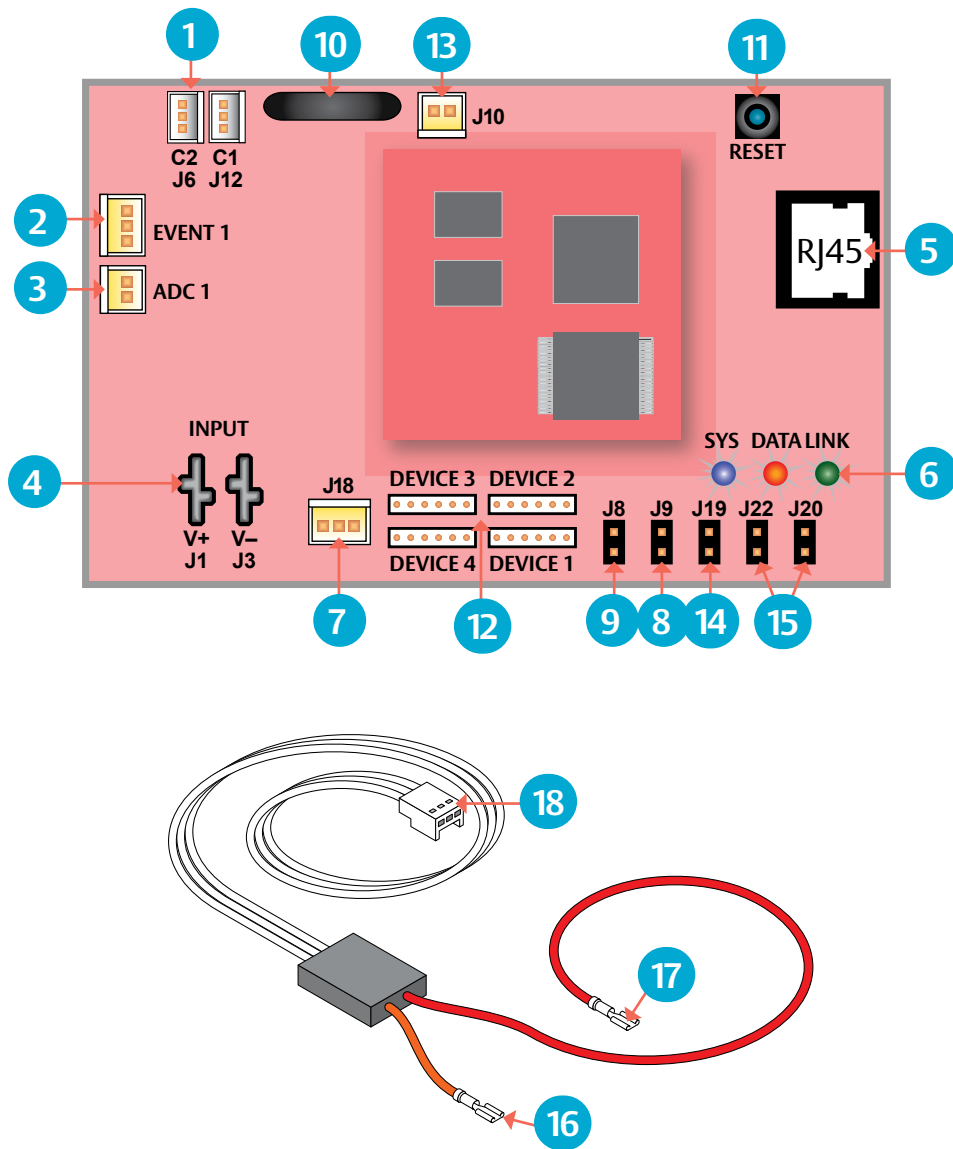

Making the Power Connections to the Securitron Netlink

DC Systems ONLY

In a DC system, the DC power source for the Securitron Netlink is connected to the INPUT (V+ & V-) fastons. The voltage of this source must be between 8 and 30 VDC and should be backed up with a battery set or UPS to maintain communication during a loss of primary AC voltage.

The power connections for the Securitron Netlink must connect directly to the main or aux output of the Securitron AQL power supply.



-  **NOTE:** Do not power the Securitron Netlink through another accessory board's output or from the B1/B2 connectors.
-  **WARNING –** Do not connect ac power to the Securitron Netlink board's input (v+ & v-) terminals or damage to the Securitron Netlink will occur.

Diagram 2: Power the Securitron Netlink from the Securitron AQL main or aux output terminals.

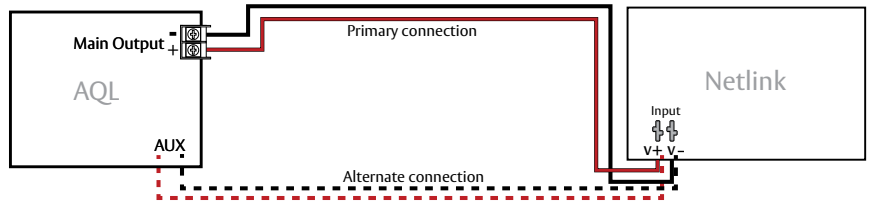
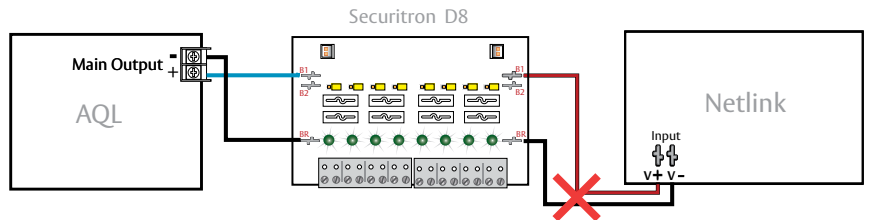

Diagram 3: DO NOT Power from another accessory board's output



Making the Ethernet Connection to the Securitron Netlink

Plug the Ethernet cable into the RJ45 jack on the Securitron Netlink until the locking tab clicks. Connect the other end of the Ethernet cable to the network.

-  **NOTE:** The Securitron Netlink board should be configured via a direct connection to a laptop or PC before connecting to the network. See the Initial Configuration Section (page 23) of this manual for more details.

Connecting Devices to be Monitored to the Securitron Netlink

Connect one end of the SPI cable to one of the “Device” connectors on the Securitron Netlink. Connect the other end to the DataLink (DL) connector of the device to be monitored (such as an Securitron AQL – see the manual for the device being connected for the location of the DL connector). If monitoring more than one device, repeat this process for devices 2 through 4 as appropriate. Note that both ends of these cables are keyed and will only plug in one direction.

If monitoring the battery health of Securitron AQL power supplies using the Current Sensors, the Securitron Netlink will assign Current Sensor 1 to the Securitron AQL power supply connected to Device 1. Current Sensor 2 will be assigned to Device 2.

-  **NOTE:** NL4 can accommodate any combination of a maximum of two power supply boards.

Diagram 4: SPI Cable

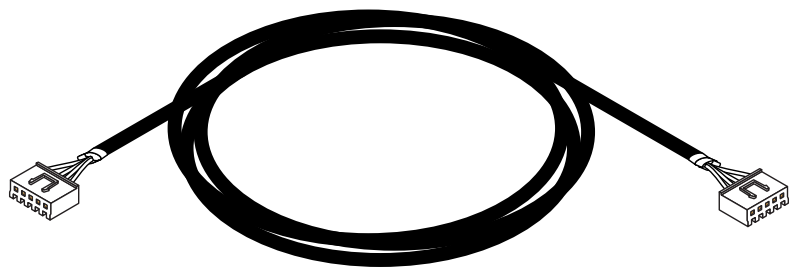

Connecting the Current Sensor(s)

Typically, the current sensor is used to measure battery discharge current to allow battery testing and utilization of the Battery Condition bar graph. In this application, the short orange lead connects toward the power supply and the long red lead connects toward the battery. See Diagram 5 for wiring details.

If not using the current sensor for the battery, connect the Current Sensor in-line with the device(s) to be monitored. To read current in the correct polarity, the positive current should flow from the longer (red) lead to the shorter (orange) lead on the current sensor. If current is being displayed in the opposite polarity than expected, swap the short/orange and red/long leads.

After connecting the red and orange leads, connect the white cable to the "C1" or "C2" connector on the Securitron Netlink.

Connecting the Event Input

Connect one end of the Event cable to the Event1 connector on the Securitron Netlink board and cut off the connector at the other end of the Event cable. Connect the red and black wires to the voltage to be monitored. If monitoring a relay or switch contact (a common example would be the tamper switch of the enclosure), an external voltage must be run through the contact. Set the Event1 Input Invert Jumper as required.

Example:

To monitor the NC tamper switch in a Securitron enclosure, connect a positive voltage (from the Securitron AQL power supply or distribution board) to one lead of the tamper switch. Connect the other lead of the tamper switch to the red (positive) lead of the Event cable. Connect the black (negative) lead of the Event cable to the negative (DC Common) of the voltage source. (Diagram 6, next page) Since we want to cause an alert on the removal of voltage, leave the Event1 Input Invert Jumper OFF.

Diagram 5

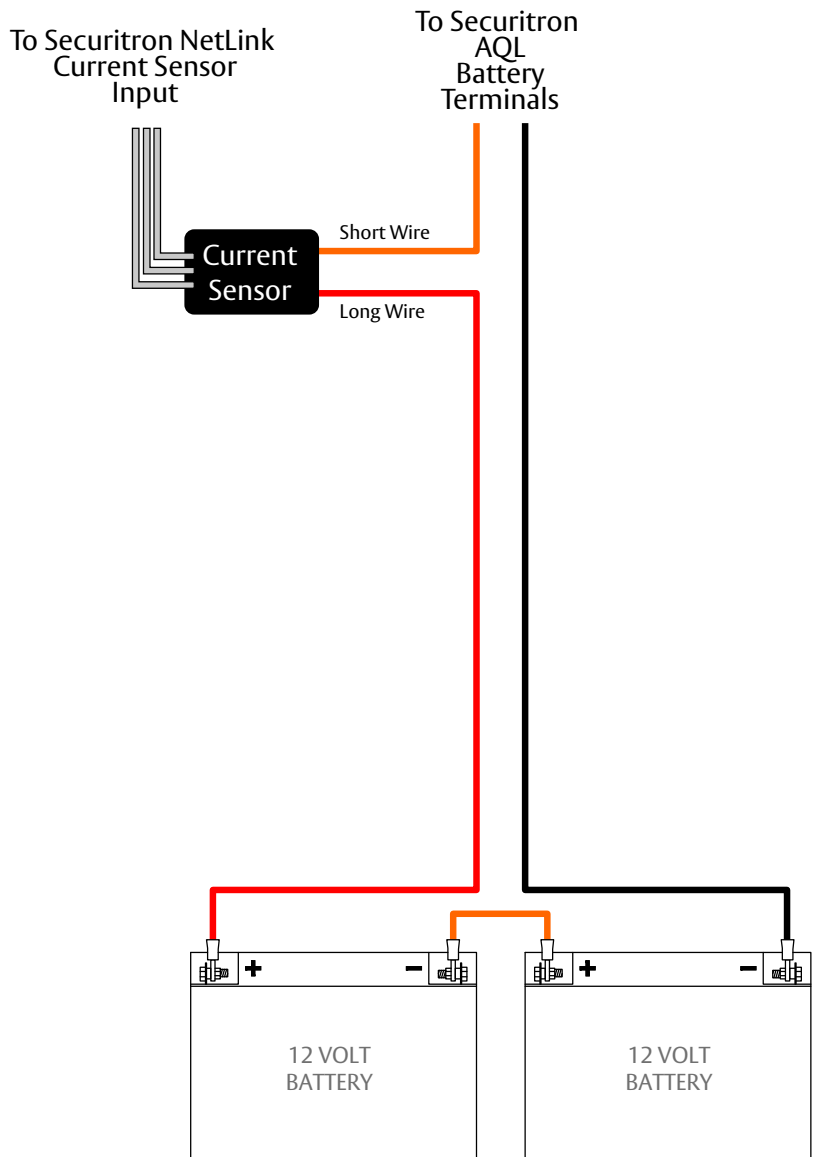

Diagram 6

Remote Temperature Sensor

The remote temperature sensor allows measuring a temperature up to 6 feet away from the Securitron NL4 board. Plug the sensor into J18 and run the sensor wire to the area or device to be monitored.

Connecting the ADC (Voltmeter) Input

When using the voltmeter input, connect one end of the ADC cable to the ADC1 input on the Securitron Netlink board. Cut off the other end of the ADC cable and connect it to the voltage source to be monitored, observing polarity. The red wire is the positive input and the black wire is the negative (DC Common) input. The ADC cable wiring must be routed away from high voltages and the wire used must be rated for the voltages and temperatures in the area in which it is installed.



NOTE: The voltage being measured by the ADC input **MUST** be common grounded with the voltage source of the Securitron Netlink board.

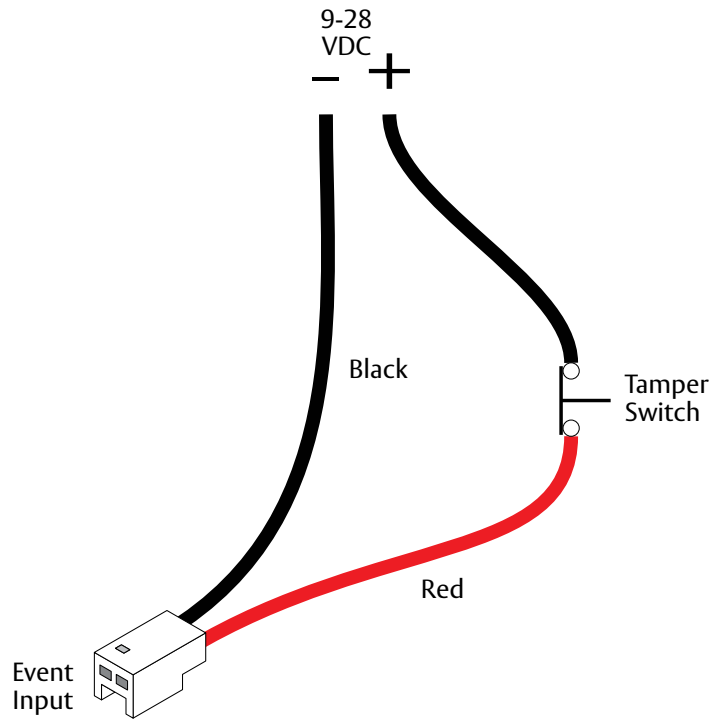

Wiring the Control Outputs

When using the control outputs, connect one end of the Control Output cable to the Control Outputs connector on the Securitron Netlink. Cut off the other end of the control output cable. The wire going to the pin on the connector labeled "FLT" is Control Output # 1. The wire going to the pin labeled "EN_FAI" is Control Output #2.

The Control Outputs are low-current, open collector (transistor) outputs which pull to ground when activated. These outputs can be used to activate sensitive trip relays such as LifeSafety Power's RB Series, supply the ground side to an FAI Input, or other similar uses. See Diagram 7, for an example using an RB relay.

Diagram 7

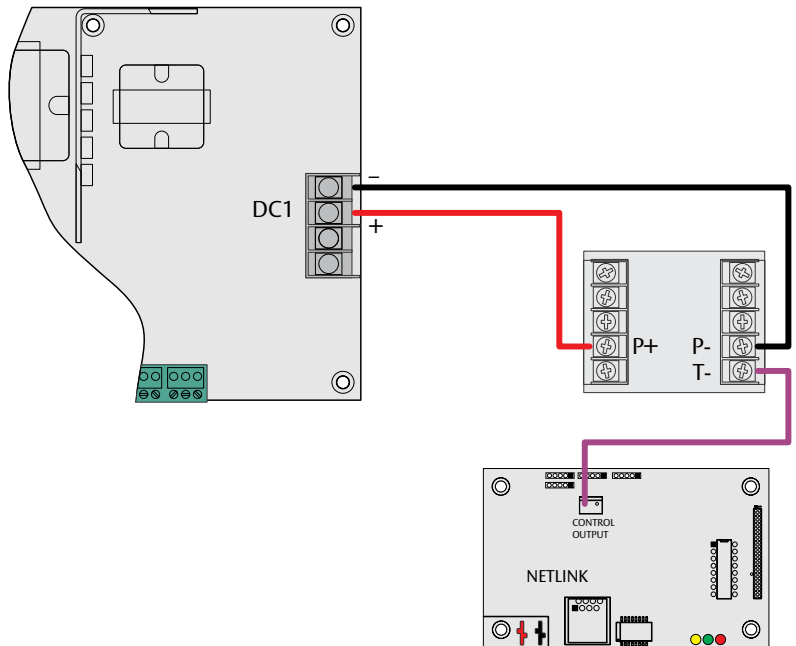

NOTE: Do not connect these outputs directly to a voltage source or damage to the Securitron Netlink will occur. Also, ensure the wire used is rated for the voltages and temperatures in the area which it is installed.

Before connecting the Securitron Netlink to a network for the first time, the board must be configured using a laptop.

 All screens shown are of the NL4 GUI. screens are similar, with changes as noted in the text.
If using DHCP, a Network Scan Tool used for finding Securitron devices is available at <http://www.lifesafetypower.com/support/software-firmware-downloads>

Preparing to configure the Securitron Netlink board

In order to perform the initial configuration of the Securitron Netlink, you will need the following:

- A computer (PC or Mac) set to a static IP address in the subnet 192.168.1.xxx, where xxx is a subnet address (0 to 255) not being used by any other device on the network. Do not use 192.168.1.9 or the final IP address you will be using for the Securitron Netlink. Disable any active WiFi connections. See image on right.
- A web browser installed on the computer.
- A standard (not crossover) Ethernet cable long enough to reach between the computer and the Securitron Netlink.
- The Securitron Netlink to be configured must be wired into the system and powered. After powering the Securitron Netlink, wait for it to initialize - when ready, the blue SYS LED will be lit steady.
- After the Securitron Netlink is powered within the system and initialized, connect the Ethernet cable between the Ethernet ports of the computer and the Securitron Netlink.

Example of a PC Ethernet Port settings Window

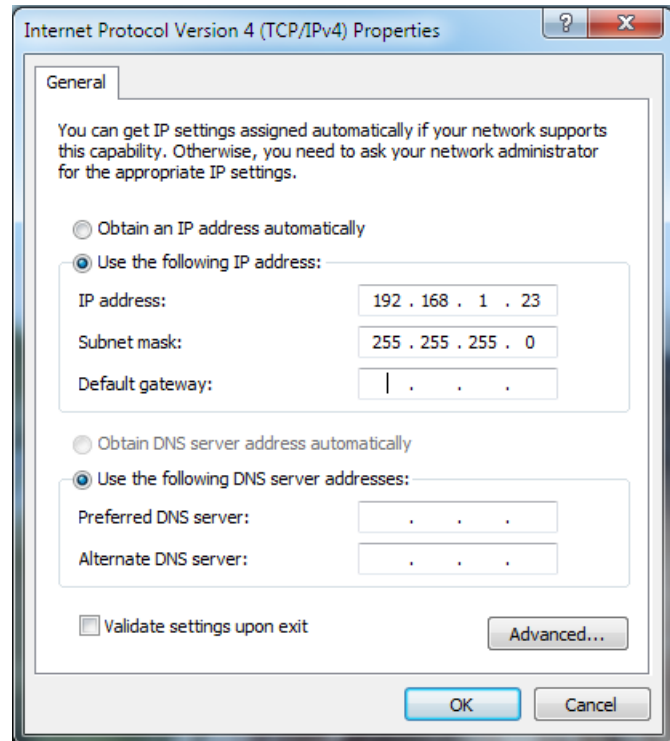

Logging into the Securitron Netlink for the first time

From the factory, the Securitron Netlink is preset with the following settings:

- **IP Address:** 192.168.1.9
- **Username:** admin
- **Password:** admin

Open a browser on the computer and enter the IP address into the address bar. When prompted, enter the user name and password. Note that BOTH are case sensitive. The Securitron Netlink License Agreement and one or more Cybersecurity windows will also appear. Read these and click **OK** (next page). The home page for the Securitron Netlink should appear in the browser window. See image next page.

Securitron Netlink Login Window
(may appear different, depending on browser)

System Login	
User Info	
Username	<input type="text"/>
Password	<input type="password"/>
Remember Password	<input type="checkbox"/>
<input type="button" value="Login"/>	

 **NOTE:** If the wrong password is entered three consecutive times, the user will be locked out of the device for the programmed lockout time (24 Hours by default). Enter the password carefully to avoid lockout. This time period may be changed on the configure page.

Resetting the Securitron Netlink

- To reset the Securitron Netlink to factory default user name and password press and hold the **Reset** button for 10 seconds.
- To reset the Securitron Netlink to factory default user name, password, IP address, certificate, and Cipher Suite settings, press and hold the **Reset** button for 30 seconds.
- After releasing the button, the Securitron Netlink will reset and reboot.
- Depending on the firmware revision, the Securitron Netlink may default to DHCP after reboot. If a DHCP server is found, an IP address will be assigned. The LifeSafety Power scan software, or a third party software must then be used to find the IP address of the Securitron Netlink.

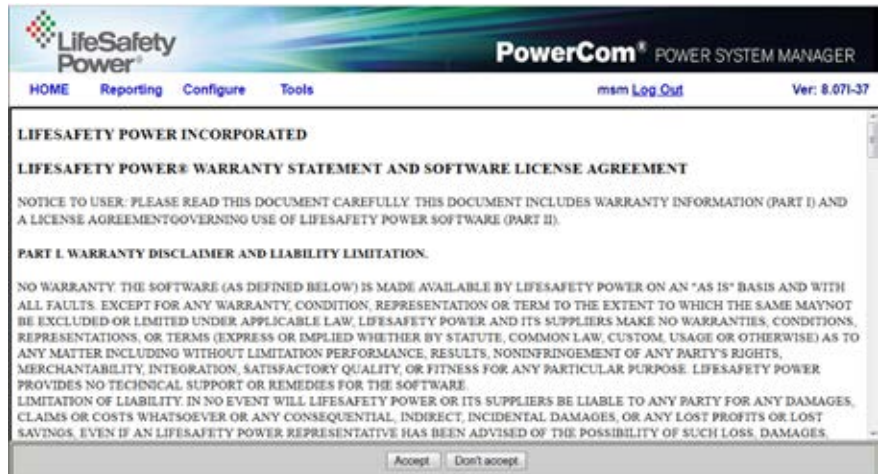

Configuring the TCP/IP Settings

- 1 In the menu bar at the top of the browser screen, click the **Configure** link.
- 2 In the TCP/IP Settings block of the Configuration screen, set the TCP/IP settings to the desired values for the network to which the Securitron Netlink will be connected.

Consult your IT department for information on these settings.

- After completing the TCP/IP settings, click the **Submit** button in the bottom right corner of the TCP/IP Settings box. Note that the new TCP/IP settings will not take effect until the Securitron Netlink is rebooted or power to the Securitron Netlink is cycled.
- If the Securitron Netlink is connected to a DHCP network and DHCP is enabled, the DHCP server will automatically configure the TCP/IP settings. Note that you will need the Network Scan tool available at <http://www.lifesafetypower.com/support/software-firmware-downloads> to locate the Securitron Netlink's IP address before logging into the Securitron Netlink board.

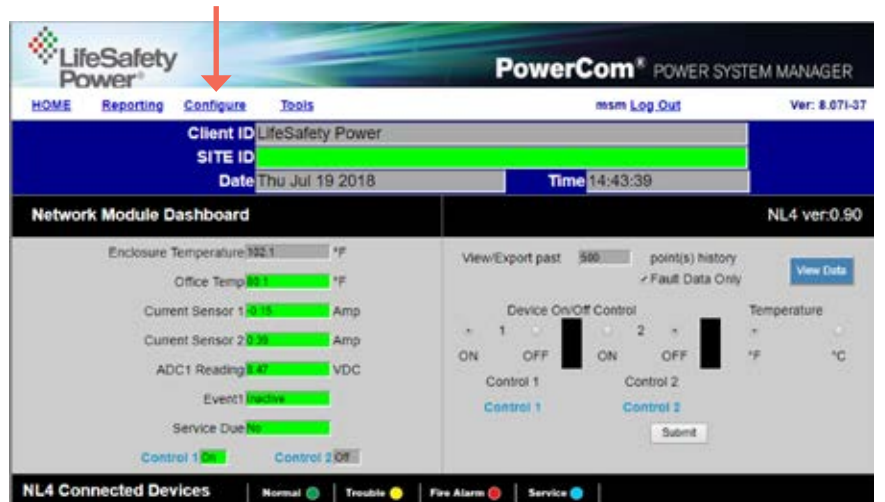

- NOTE:** The port number used by the Securitron Netlink can also be set in the Port# field. By default the Securitron Netlink is set to use port 80. To disable HTTP access and only allow access via HTTPS, check the "Disable HTTP" selection.
- NOTE:** To access the Securitron Netlink board from outside the installation site's firewall, the firewall must have the ports used by the Securitron Netlink for http/https, and SNMP (if used) open. See your IT department for firewall port opening details.

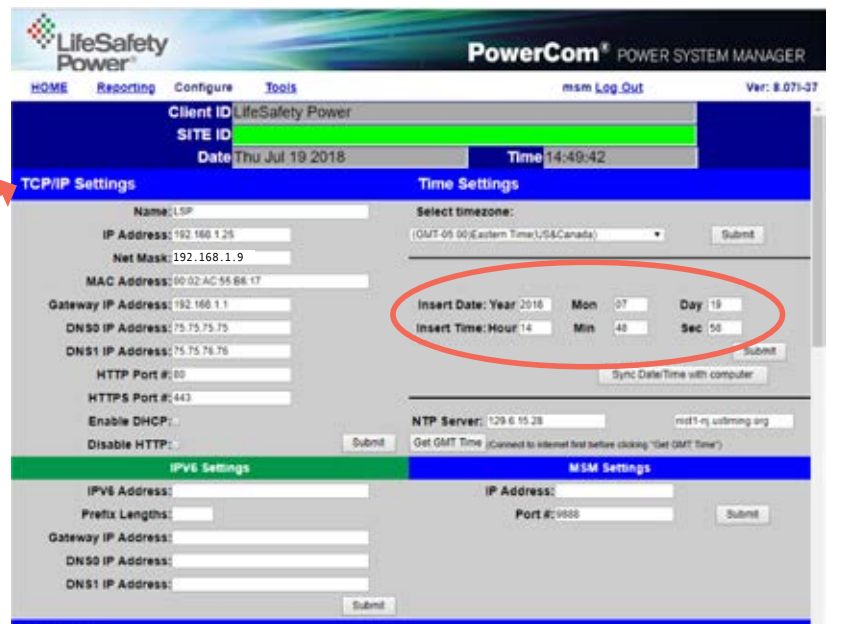

Time Settings

The Time Settings block on Configuration Page (See page 24, circle) is where the time and date are programmed into the Securitron Netlink. First, select the correct time zone from the drop down list and click [Submit](#). After the time zone is set, the time and date can be set one of three ways:

Manual Entry

Enter the correct time and date in the following format and click the [Submit](#) button:

- For Date: **YYYY MM DD**
- For Time: **HH MM SS**

! ALWAYS enter two digits in time field..ie., 7AM = 07, not 7 The new date and time will take effect immediately.

Sync With Computer

The [Sync Date/Time with computer](#) button will set the date and time of the Securitron Netlink to match the computer currently being used to access the Securitron Netlink. The new date and time will take effect immediately.

Using an NTP Server

The NTP Server fields allow you to enter one or two NTP servers for automatic setting of the time and date via the internet. The Securitron Netlink must be configured for internet access before this setting will work. Either the IP address of the server or the DNS name of the server may be entered. After entering at least one server, click the [Get GMT Time](#) button to set the Securitron Netlink time and date. Depending on server traffic, it could take several seconds for the time setting to complete.

MSM Settings

Securitron AQL Power Supplies are not currently compatible with the LSP MSM Enterprise Server. LifeSafety Power FPO or FPG power supplies are required for MSM compatibility.

Configuring the SNMP Settings

Scrolling down in the Configure page reveals the “SNMP Settings” section.

In the SNMP Setting block, under the “Basic” heading, set Read and Write Community to “public” and set Location to a meaningful name of your choice. This entry will help you identify the specific Securitron Netlink board when multiple Securitron Netlink boards are installed on the same subnet. This entry will be read by an SNMP system as “syslocation”, OID .1.3.6.1.2.1.1.6. The port used for SNMP may also be changed in this section (161 Default). Be sure to open the SNMP port if accessing SNMP outside your firewall. Below the port number setting, select the trap type (Trap or Inform). Click the [Submit](#) button at the bottom of the “Basic” section to save the settings, otherwise you will lose the settings. These settings will take effect after a reboot of the Securitron Netlink.

The “**Security Name**” section of the SNMP Setting block allows you to grant only specified computers (by IP address) SNMP v1 and v2 access. Since v1 and v2 do not have password protection, the Security Name settings add security to v1 and v2 access. The web server is password protected and a user must have the web server password in order to setup a computer in the Security Name settings and gain v1 and v2 access. Multiple source networks can be added to the Security Name Setting block. Be sure to click the [Submit](#) button to save the settings. The settings will take effect after a reboot of the Securitron Netlink.

The “**V3 User**” section of the SNMP Setting block allows for a user to set up an SNMP v3 user name and password. With a user name and password, the Securitron Netlink board may be accessed from anywhere via the internet by using the SNMP v3

protocol. No security name setup is required for v3 users and multiple v3 users may be set up in the same table. Click the [Submit](#) button to save the settings, which will take effect after rebooting the Securitron Netlink.

The SNMP Trap Receiver IP and Port settings should be set to the proper address for the SNMP Trap receiver. Click the [Submit](#) button and reboot the Securitron Netlink for the settings to take effect. The SNMP Trap Version may be selected using “Select Trap Version”. The SNMP Inform Log may be seen by clicking the [Show Inform Log](#) button. If the trap type is set to “Trap”, no data will be displayed in this section. Click [Hide Inform Log](#) to hide the log window.

Typical Configuration page (upper-middle portion)



Configuring the Email Settings

The Securitron Netlink can be configured to send email alerts on user-specified conditions and periodic status reports. Underneath the SNMP Settings block on the Configure page is the Email Settings block.

Under “Receive Addresses”, the email address or addresses to receive the alerts and reports should be entered. Up to four recipient email addresses may be entered.



NOTE: Regarding Microsoft Exchange – By Default, Microsoft Exchange will not accept SMTP connections. To use the Securitron Netlink’s email functions through Microsoft Exchange, the Exchange service must be configured to allow SMTP connections. Consult with the administrator of your Microsoft Exchange Server.



NOTE: Click the Submit button to save the settings, which will take effect after rebooting the Securitron Netlink.

TIP: Most mobile phone providers have an email address available which will convert an email into an SMS text message. This email address is usually in the form of: (the mobile phone number)@xxxxxx. Consult with your mobile provider for more information. The CSV attachment will be removed, since SMS text messages are not compatible with attachments. Because of this, it is recommended that the SMS email be entered as an ADDITIONAL “Receive Address” on the Securitron Netlink, so that the CSV file will still be available via regular email.

Under “Sender”, the settings of the account to send the emails should be entered. These settings include:

Sender SMTP Server	This is the address of the SMTP server for the email provider. Consult with your email provider for this address.
Sender’s Email	This is the email address which the Securitron Netlink will use to send emails.
Sender Email Password	This is the password associated with the Sender’s Email account.
TLS	Check this box if your email provider requires TLS or SSL encryption.
SMTP Port #	Enter the port number required by your email provider for sending email. Usually this is “25”.
Authentication	Choose the proper authentication method for your email provider from the drop-down list. Usually, this is “login”. Select “off” to completely disable authentication.
Send Period	Selects how often the Securitron Netlink sends a regular email status report. The period can vary from 1 hour to 6 months or, if you do not want the Securitron Netlink to send periodic reports, select “Never”. Note that the “Send Period” setting does not affect the sending of email alerts generated on faults or events selected by the user, only the periodic status report.

The Email Test Section

Below the Email Settings section is the Email Test section. After configuring the email settings, the Email Test button will send a test email to all Email Receive addresses. Please note that it could take an hour or more to receive the email, depending on the speed of your email server. Clicking the Show Email Log button will show the feedback from the email server. This can be useful for diagnosing email problems.

VPN Settings

The VPN Settings section is not utilized on Securitron AQL Power Systems.

Configuring the Securitron Netlink Network Module Settings

Below the VPN Settings block is the Network Module Settings block, where application-specific parameters of the Securitron Netlink can be set.

Client ID	Enter any meaningful name to help identify the site or customer. The Client ID will appear at the top of the home page.	Control 2	Enter a name for the Control 2 output. This label will appear below the Securitron Netlink Control Setting 2 radio buttons on the home page.
Site ID	Enter any meaningful name to help identify the installation site. The Site ID text will appear at the top of the Home page, as well as in the subject line of email alerts and reports.	ADC1 Reading	Enter a name indicating the voltage being measured by the ADC input of the Securitron Netlink. This reading is the voltage between the two ADC input pins. In the example, the label is "ADC1Reading".
Data Buffer Interval	This selects the time period between "snapshots" of the data for the email/csv reports. Typically, this value should be set to 24 hours.	ADC1 Lower Limit	This is the lower voltage limit for the ADC1 input. If the measured voltage goes below this value, an alert will be generated. By default, this value is set to -30 V to disable the limit.
Password Lockout Delay	Selects the length of time to lock out a user after three consecutive incorrect password attempts. Selections range from 5 minutes to 24 hours.	ADC1 Upper Limit	This is the upper voltage limit for the ADC1 input. If the measured voltage goes above this value, an alert will be generated. By default, this value is set to 30 V.
External Event	Enter a name related to the usage of the Event1 input. In the example, this setting is labeled "Event1".	External Temperature	Enter a name for the external temperature measurement.
Current Sense 1	Enter a name indicating the current being measured by the current sensor connected to the C1 connector of the Securitron Netlink. In the example, the label is "CurrentSensor1".	Lower Limit Temperature	Enter a lower temperature limit for the external temperature sensor input. If the temperature measured by the sensor goes BELOW this value, an alert will be triggered.
Current Sense 1 Lower Limit	This is the lower current limit for Current Sensor 1. If the measured current goes below this value, an alert will be generated. By default, this value is set to -3A to disable the limit.	Upper Limit Temperature	Enter an upper temperature limit for the external temperature sensor input. If the temperature measured by the sensor goes ABOVE this value, an alert will be triggered.
Current Sense 1 Upper Limit	This is the upper current limit for Current Sensor 1. If the measured current goes above this value an alert will be generated. By default this value is set to 15 A.	Next Service Due	Enter a date indicating the next service due date. If "Service Due" is selected as an email alert condition, an alert email will be sent out to the specified email recipient(s) when the system time matches the due date time.
Current Sense 2	Enter a name indicating the current being measured by the current sensor connected to the C2 connector of the Securitron Netlink. In the example, the label is "Current Sensor 2".	Reminder Message	Enter a brief message to indicate the type of service which is due in the email alert. This message will appear in the Subject line of the alert email.
Lower Limit Current Sense 2	This is the lower current limit for Current Sensor 2. If the measured current goes below this value, an alert will be generated. By default, this value is set to -3 A to disable the limit.		
Upper Limit Current Sense 2	This is the upper current limit for Current Sensor 2. If the measured current goes above this value an alert will be generated. By default this value is set to 15 A.		
Control 1	Enter a name for the Control 1 output. This label will appear below the Securitron Netlink Control Setting 1 radio buttons on the home page.		



NOTE: After entering the above information into the Securitron Netlink Network Module Setting block, click the **Submit** button to save the settings. These settings will take effect immediately without rebooting the Securitron Netlink board.

User Settings

In the User Settings block of the Configure screen, you can enter the user names, passwords, access levels, and password complexity for the Securitron Netlink board.

The default user is “admin” and the password for this account is also “admin”. It is highly recommended to change this user name and password for security reasons. Click [Submit](#) when done. Note that there must ALWAYS be at least one admin-level user.

Adding a New User

To add another user, first select the Authorization level desired for the user. Three authorization levels are available:

- **ADMIN** Admin-level users have full control over the Securitron Netlink. There are no restrictions.
- **MANAGER** Manager-level users have access to all areas of the Securitron Netlink except for the Configure page.
- **GUEST** Guest-level users may only view information on the Securitron Netlink screens. No changes can be made and none of the control features are available.

After selecting the Authorization level, enter the new user name in the User Name column and enter the password into the Password column. Passwords must meet the complexity level setting requirements. Re-enter the password into the Verify Password column.

After clicking [Submit](#), the new user will be active and another blank row will appear for entering the next user name.

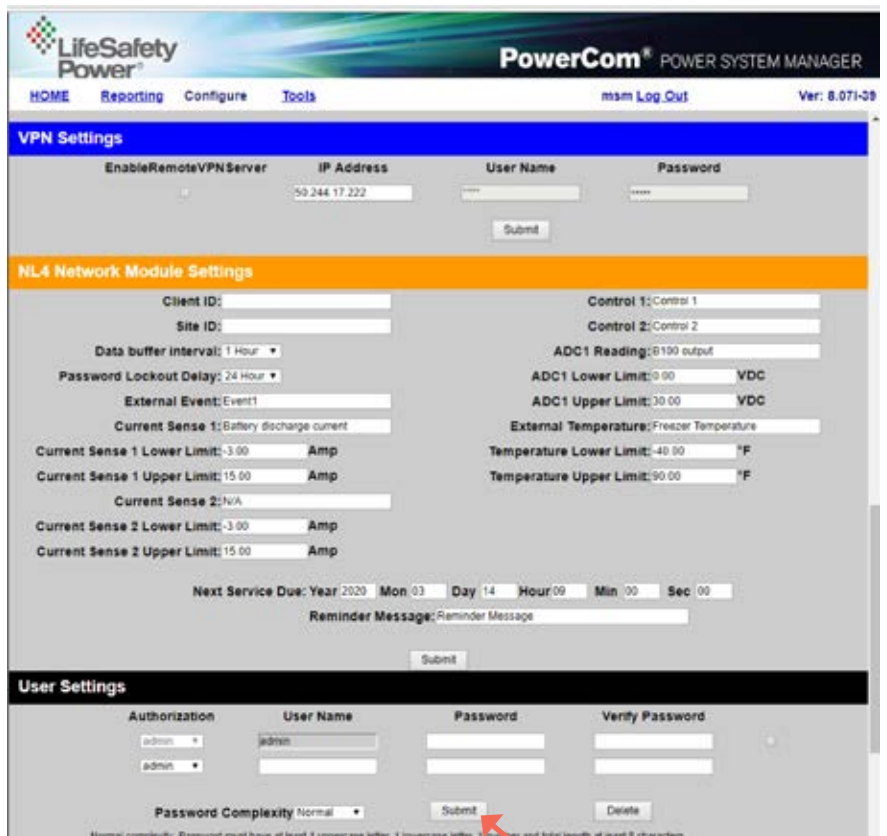

Select Certificate

The Securitron Netlink allows a user-supplied certificate to be used. Click the [Select Certificate](#) button to enter the Import Certificate screen. Contact your IT department for more information.

- 1 Click the [Choose File](#) button to select the certificate to be used, then click [Download](#), then [Confirm](#) to download the certificate.
- 2 Click the [Submit](#) and [Test](#) button to use and test the certificate.

SSL Protocol & CipherSuite Settings

This section allows the user to select which SSL protocol to use. The default setting is Normal.

Certificate Log

- Click [Show Certificate Log](#) to view the certificate activity log.
- Click [Hide Certificate Log](#) to hide the window.



Import & Export Configuration File

The Securitron Netlink allows the user to export the settings that are configured in the Securitron Netlink to a file. This file can be used as a backup or to transfer these settings to other Securitron Netlink devices that require similar settings. The settings exported include:

- **From Configure Page:** Time Settings (including NTP Server), MSM Settings, SNMP Settings, VPN Settings, Securitron Netlink Module Settings, User Settings.
- **From Reporting Page:** Alert Enable On, Securitron Netlink Report, AQL1/2 Report.
- **Power Supply Settings (AQL)** – For all connected power supplies.

To export the settings, click the [Export Configuration File](#) button. The exported file saves to the default download location of the browser.

To import a configuration file, click the [Import Configuration File](#) button to open the Import Settings screen.

Click the [Choose File](#) button and select the configuration file to be imported. Click [Download](#), then [Confirm](#) to import the settings.

User Login Record

Click the [Show Login Log](#) button to show the history of login information for the Securitron Netlink board.



Setting up the Parameters for the Email Reports

The Securitron Netlink can send email alerts based on selectable conditions. If enabled, when the selected conditions are met, the Securitron Netlink will send an email with an attached report file (in CSV format). To set up the email alert conditions, click the [Reporting](#) link in the top menu.

Select the Email Alert Triggers

The “Alert Enable On” block of the Reporting page contains checkboxes for the various conditions that can cause an email alert to be sent.

System Fault	If checked, a System Fault condition on a connected device will generate an email alert.
AC Fault	If checked, an AC fault condition on a connected device will generate an email alert.
Battery Backup Time	If checked, an alert will be generated if the required standby time is not able to be met with the installed battery.
Current Sensor 1	If checked, a current outside the range set for Current Sensor 1 will generate an email alert.
External Temperature	If checked, an external temperature outside of the range set will generate an email alert.
Event1	If checked, a valid input on the Event1 Input will generate an email alert.
FAI Active	If checked, an active FAI Input on a connected device will cause an email alert.
Current Sensor 2	If checked, a current outside the range set for Current Sensor 2 will generate an email report.
Battery End of Life	If checked, an email alert will be sent when the Battery Runtime of the connected device reaches the "Rated Battery Life" setting on the Configure page. When a new battery is installed, the "Reset Timer for New Battery Installation" box on the Programming page should be set to reset the Battery Runtime counter.
Battery Condition	An email alert will be sent when the battery charge is less than 20% (one yellow bar on the "Bat. Condition" display on the power supply page).
ADC1 Reading	If checked, a voltage outside the range set for ADC1 will generate an email report.
Service Reminder	An email alert will be sent when the "Next Service Due" date and time on the Configure page are reached.
Device Detect	An email alert will be sent when a device is connected or disconnected from the Securitron Netlink board. This will notify the email recipient if the Securitron Netlink loses communication with a connected device.

After setting the email alert triggers, click the [Submit](#) button at the bottom of the “Alert Enable On” section for the settings to take effect.

Select the Occurrences to Report

The “Select Occurrences to Report” block of the Reporting page allows the setting of the number of history events to be included in the report file attached to the alert email (example right). The Securitron Netlink records a snapshot of device parameters at the time period selected on the Configure page. Up to 1000 history events can be recorded. The user can enter between 1 (the latest event only), up to 1000 (for all events). After entering the number of history events to email, click the Submit button to save this setting.

Select the Devices and Parameters to Report

The bottom section of the Reporting page contains the devices and parameters selection area. Any connected devices will show here, along with a section for the Securitron Netlink itself.

The Securitron Netlink and each device also have selectable parameters listed below their headings. Checking these parameters will add them to the report attached to the email alert. These are the same parameters as seen on the Home page.

Available Securitron Netlink parameters

include: enclosure temperature, external temperature, current sensor readings, the ADC1 reading, and the Event Status (these may appear as the labels set on the Configure page).

Available Securitron AQL parameters include:

Model Number, System Fault Status, AC Fault Status, FAI Status, FAI Latch Status, Securitron AQL Output Voltage, Battery Voltage, Battery Charge Current, Total Power-up time, Battery Installed time, AC Fault Total, System Fault Total, Battery State Of Charge, Battery Runtime Test Total, Battery Runtime Test Failed Total, Required Standby, and Actual Standby.

After setting the devices and parameters to be reported, be sure to click the Submit button for each device.

Typical Reporting Page

The screenshot displays the PowerCom POWER SYSTEM MANAGER interface. At the top, there are navigation tabs: HOME, Reporting, Configure, and Tools. The user is logged in as 'mam' and can click 'Log Out'. The version is 'Ver: 8.071-39'. The client information shows 'Client ID: LifeSafety Power' and 'SITE ID' (partially redacted). The date is 'Thu Aug 09 2018' and the time is '13:49:18'. There is a 'Send Email Report' button.

The 'Alert Enable On' section contains a grid of parameters with dropdown menus and a 'Submit' button:

- System Fault
- AC Fault
- Battery Backup Time
- Office Temp
- Event1
- FAI Active
- Current Sensor 1
- Current Sensor 2
- Battery End of Life
- Battery Condition
- Current Sensor 2
- Service Reminder
- Device Detect
- ADC1 Reading

The 'Select Occurrences to Report' section has a 'Select:' dropdown set to '1000' and a 'Submit' button.

The 'NL4 Report' section lists parameters with checkboxes and buttons:

- Current Sensor 1
- Current Sensor 2
- ADC1 Reading
- Event1
- Enclosure Temperature
- Office Temp

The 'FP1 Report' and 'FP2 Report' sections list parameters with checkboxes and buttons:

- Model Number
- System Fault Status
- AC Fault Status
- FAI Status
- FAI Latch Status
- FPO Output Voltage
- Battery Voltage
- Battery Charge Current
- Total Power-up Time
- Battery Installed Time
- AC Fault Total
- System Fault Total
- Battery State of Charge
- Battery Runtime Test Total
- Bat Runtime Test Failed Total
- Required Standby
- Actual Standby

Viewing System Parameters on the Securitron Netlink Home Page

Before system parameters can be viewed, you must be logged into the Securitron Netlink board using the proper IP address, user name, and password for the Securitron Netlink.

The Home page contains all of the real-time parameters monitored directly by the Securitron Netlink as well as status of the connected devices. The Home page is broken into several sections as follows.

Basic Site Information

The top portion of the Securitron Netlink Home page lists the Client ID and Site ID (as programmed on the Configure page) as well as the system time and date. The Site ID field will be green if there are no faults or service alerts detected. This field will turn yellow on any fault condition or blue on any service alert conditions.

Typical Securitron Netlink Home Page

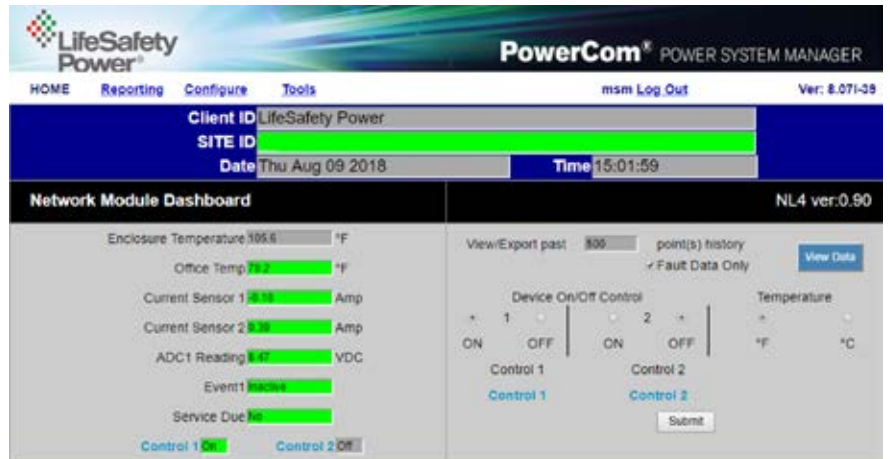

Network Module Data, History & Control Sections

Below the Basic Site Information are the parameters and settings related to the Securitron Netlink board and the Web Interface itself.

Enclosure Temperature	This is the temperature of the Securitron Netlink board. This temperature sensor is installed on the Securitron Netlink's PC board.
External Temperature	If an external temperature sensor is connected to J18, this temperature display will display the external sensor's temperature.
Current Sensor Measurements	These will appear as the labels you set for the Current Sensors on the Configure page. These measurements are shown as a positive or negative current in Amps DC. A positive current measurement indicates current flow from the longer red lead of the current sensor to the shorter orange lead of the current sensor. If current is being displayed in the opposite polarity than expected, swap the short and long red leads. <i>See page 21 for more information on the current sensor.</i>
ADC Voltage Measurement	This is the voltage measured by the on-board Analog-to-Digital converter (ADC) and will appear as the label you set for the ADC input on the Configure page. This measurement is shown as a positive or negative voltage in Volts DC.
Event1 Indicator	This field shows the status of the Event1 input. It will appear as the label set for the Event1 input on the configure page. This field will show "Active" on a yellow background or "Inactive" on a green background to indicate the status of the Event1 input.
Service Due	This field will display "Yes" when the "Next Service Due" date programmed on the Configure page has been reached and will display "No" before the due date. If the "Service Due" checkbox is enabled on the Reporting page, the color of the "Service Due" field will be blue if service is required or green if not required.
Control 1 & Control 2 Status	These fields indicate the state of the two control outputs of the Securitron Netlink. These control outputs will be labeled with the names given on the Configure page and can be changed with the Output Control radio buttons to the right. The Control 1 and Control 2 fields will display "Off" with a gray background or "On" with a green background.
View/Export History	The Securitron Netlink saves a snapshot of data at the programmed interval. These snapshots can be reviewed by entering the number of events to view or export then clicking the View Data button. To view only the detected fault data, check the Fault Data Only box before clicking View Data . There are up to 1000 events available for review. To save the data, click the Export to CSV File button. Click the Return button at the top to return to the home page.
Device On/Off Control	These two pairs of radio buttons select the state of the two Control Outputs of the Securitron Netlink board. After changing the radio button, the Submit button must be clicked for the setting to take effect. The labels entered for these outputs on the Configure page appear below the radio buttons.
Temperature	This changes the display of the Securitron Netlink temperature between Celsius and Fahrenheit on the browser display. The Submit button must be clicked for this setting to take effect.

Connected Devices Section

The bottom of the home page shows the devices connected to the Device connectors of the Securitron Netlink with a SPI cable. Each device will display a photo of the device and the model number. The Device ID is a unique number given by the Securitron Netlink to each device. The "Status" indicator shows the current status of the device. Green indicates a normal state, yellow indicates a fault, and blue indicates a service item. A red indicator shows that an FAI request has been received by the device. Power supplies will also display the measured output voltage. To access the page for a device, click either the photo of the device or the model number. See Accessing & Programming Connected Devices of this manual for more information on connected devices.

Accessing & Programming Connected Devices

When devices are connected to the Securitron Netlink, detailed information relating to these devices may be viewed and various parameters can be programmed through the Securitron Netlink's interface. Note that programming these parameters changes the operation of the device itself. To access the page for a device, click on the photo of the device in the Securitron Netlink Connected Devices section of the home page.

AQL Power Supplies

The Securitron AQL Power Supply page contains the same Client ID, Site ID, Time, and Date information as the Home page of the Securitron Netlink; below that are five main sections.

AQL Device Parameters & History

The section at the top left of the screen will show the available parameters of the Securitron AQL Power Supply.

Typical Power Supply Page

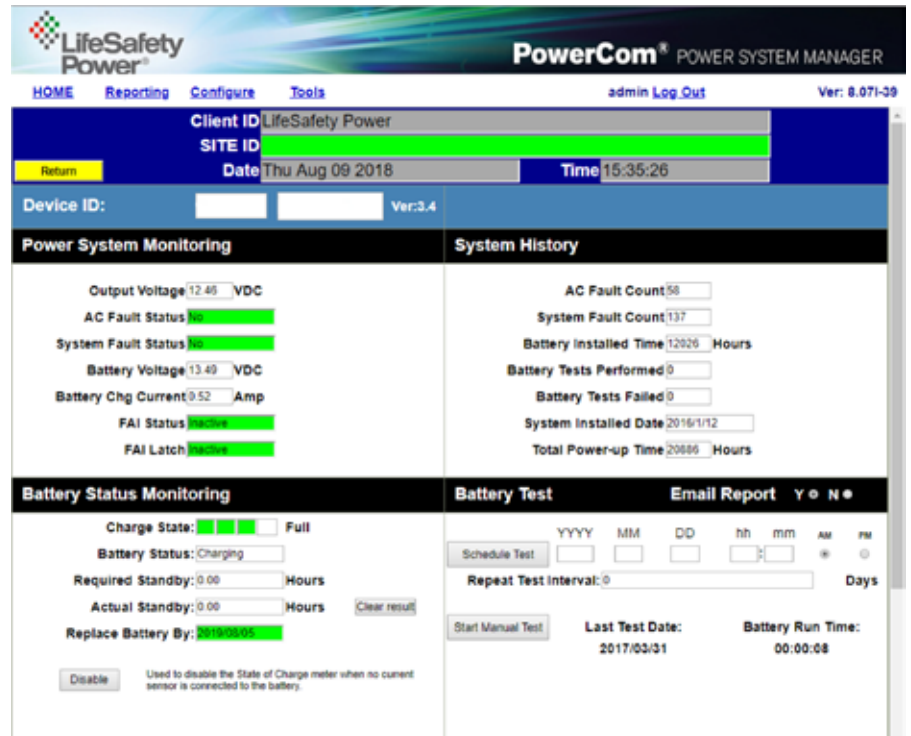

Power System Monitoring & System History

Any power supply connected to a device input will provide the following parameters:

Device ID	This is the identifying label for the device. The FP-1 or FP-2 label is given by the Securitron Netlink and is not user settable. Also displayed is the model number of the power supply.
Output Voltage	This is the measured system output voltage (in Volts DC) of the supply, as measured directly out of the power supply engine within the power supply board. This voltage is distributed to the outputs of the supply.
AC Fault Status	Indicates whether the supply is reporting a low or missing AC voltage. "No" on a green background indicates that no problem is being reported. "Yes" on a yellow background indicates an AC Fault condition. See the power supply manual to troubleshoot.
System Fault Status	Indicates whether the supply is reporting a System Fault condition. "No" on a green background indicates that no problem is being reported. "Yes" on a yellow background indicates a System Fault condition. See the power supply manual to troubleshoot.
Battery Voltage	Indicates the measured battery voltage in Volts DC. This field only indicates the terminal voltage of the battery set and does not necessarily indicate the condition or state of charge of the battery set.
Battery Chg Current	This field indicates the charge current being applied to the battery set (in Amps DC). This field only represents charge into the battery and does not show battery discharge current. Use the Securitron Netlink current sensor to measure both charge and discharge current (See Page 21).
FAI Status	This field indicates the status of the FAI Input of the supply. "Inactive" on a green background indicates that the FAI input is not activated. "Active" on a red background indicates that the FAI input is activated.
FAI Latch	This field indicates the status of the FAI Latch Input of the supply. If the Latch Input is being used and the FAI Input is active and latched, this field will show "Active" on a red background. If FAI Latch is not being used this field will show "Inactive" on a green background.
AC Fault Count	This field shows the number of AC Faults detected since the last fault counter reset. When new, a supply may contain a random number in this field and the counter should be reset (in the Power Supply Settings section) before being used.
System Fault Count	This field shows the number of System Faults detected since the last reset of the fault counter. A supply may contain random data in this field when new and the counter should be reset (in the Power Supply Settings section) before being used.
Battery Installed Time	This field displays the battery runtime in hours since the last reset of the battery runtime counter. The battery runtime field may display random data on a new supply and should be reset on the Power Supply Settings section before use. This Runtime is independent of the Battery End-of-Life / Bat. Replacement Date.
Batt Tests Performed	The total number of automated battery tests performed (See Page 21)
Battery Tests Failed	The number of failed battery tests that have occurred (See Page 21)
System Installed Date	This field allows the installer to enter the initial installation date for the power supply as a service record.
Total Power-up Time	This field displays the total power-up time in hours for the supply. This value cannot be reset. It is normal for several hours to show in this field on a new supply, due to burn-in testing at the factory.

Battery Status







The section at the left of the middle section of the screen shows the current battery status. This section will only be enabled if a current sensor is connected in line with the battery for the Securitron AQL (See page 21).

Battery State of Charge

If enabled, a bar graph will display indicating the estimated condition of the battery connected to the supply. Once the battery is connected and the Securitron Netlink detects current flow, an Enable/Disable button will appear at the bottom of the Battery Status area. If the button is enabled, a four segment bar graph display will appear with one end labeled "Full".

NOTE: It can take several minutes for an accurate indication of battery condition.

The various possible states of the Battery Condition bar graph display are as follows:

COLOR BARS	BATTERY IS AT
 4 Green Bars	80% to 100% charge
 3 Green Bars	60% to 79% charge
 2 Green Bars	40% to 59% charge
 1 Green Bar	20% to 39% charge
 1 Yellow Bar	6% to 19% charge <i>(email alert will be sent, if enabled)</i>
 1 Red Bar	5% or lower charge

When the battery discharges to one yellow bar, an email alert will be sent if the Battery Condition checkbox on the Reporting page is enabled.

- **Status** The Status field gives the state of the battery. Possible states are "Charging", "Charged", or "Discharging".
- **Required Standby** The required standby time as set in the Battery Settings section (See page 21).
- **Actual Standby** The measured battery standby time as recorded during the Battery Test (See page 21).
- **Replace Battery By** This displays the scheduled battery replacement date, which is calculated based on the current date and the "Rated Battery Life" setting entered on the Configure page. If the battery is within its calculated life, the field will be green. Once the due date has passed, this field will change to blue and an email alert will be sent if enabled on the Reporting page.
- **Enable/Disable Button** This button will enable or disable the Battery Status section. Disable the section to prevent confusion and erroneous email alerts if the current sensor is not connected in series with the battery.

Battery Run Time Test Warning

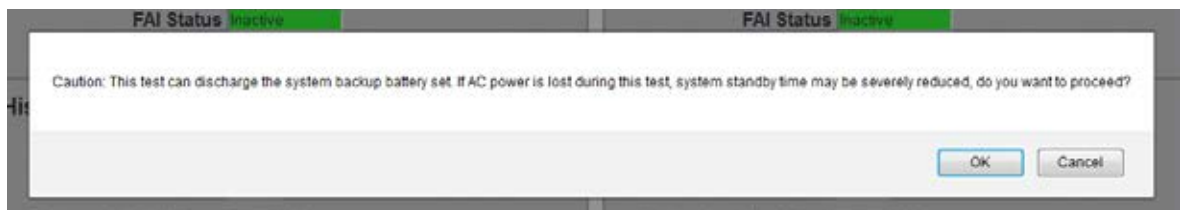

Battery Enable/Disable Button (AQL main screen)

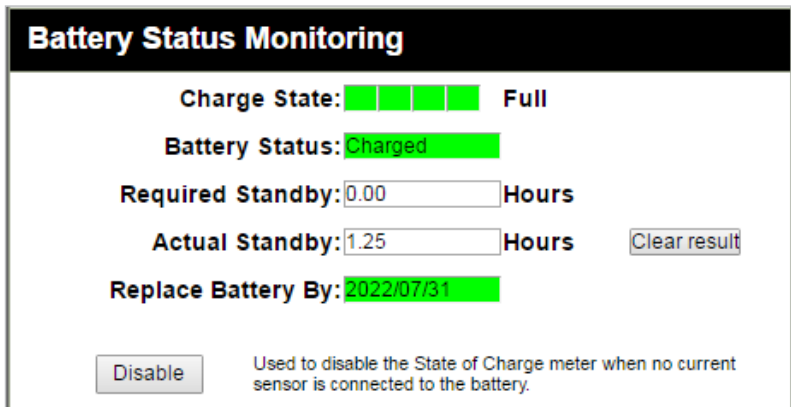

Battery Test Results

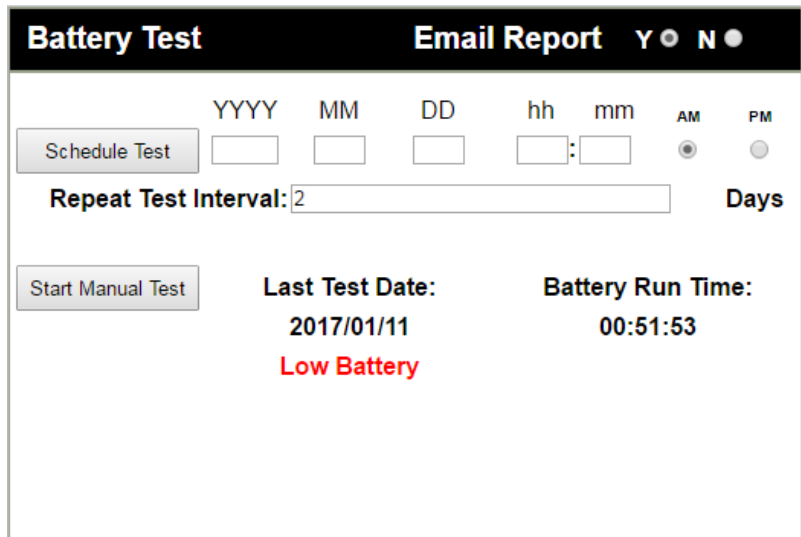

Battery Test

The Battery Test section allows the user to test the actual run-time of a system with the installed battery set. This test may be run manually or may be scheduled for a one-time or repeating automated test. If email is configured on the Securitron Netlink, a report of the results can be emailed.



WARNING: During the Battery Run Time Test, the system battery will be discharged to 85% of the nominal voltage, leaving essentially 0% battery capacity should AC power be interrupted during or immediately after the test. Appropriate measures MUST be taken to ensure the security/safety of the building and its occupants during the Battery Run Time Test.

To run a test manually

- 1 Ensure a battery set is connected to the power supply and that the Current Sensor is properly connected in line with the battery set. See page 21 for more information on the Current Sensor. The Enable/Disable button in the Battery Status section must be ENABLED.
- 2 Select whether or not you want a report emailed at the end of the test by selecting Y or N in the "Battery Test" header. Email parameters must be properly set up on the Configure page of the Securitron Netlink, or this selection will be unavailable.
- 3 Click the Start Manual Test button. A warning message will appear. Click OK to begin the test.
- 4 While the test is in progress, there will be two messages on the page - one indicating "Battery discharging..." in the Battery Test section, and one indicating "Caution Battery test in progress. System powered by battery" in the Power System Monitoring section.
- 5 At the conclusion of the test, the measured battery runtime and last test date will be displayed in the Battery Test section. The results will also be emailed if emailing is enabled.

To Schedule a Test

- 1 Ensure a battery set is connected to the power supply and that the Current Sensor is properly connected in line with the battery set. See Page 21 for more information on the Current Sensor. The Enable/Disable button in the Battery Status section must be ENABLED.
- 2 Select whether or not you want a report emailed at the end of the test by selecting "Y" or "N" in the "Battery Test" header. Email parameters must be properly set up on the Configure page of the Securitron Netlink, or this selection will be unavailable.
- 3 Enter the Year, Month, Day, Hour, Minute, and am/pm for when you want the test to begin.
- 4 Enter the test interval (in days) for repeating the battery test. For example, to run the test yearly, enter 365. Set to 0 for a one-time test.
- 5 Click the Schedule Test Button - the Scheduled Start Time will appear.
- 6 At the conclusion of the test, the measured battery runtime and last test date will be displayed in the Battery Test section. The results will also be emailed if enabled.
- 7 If the tested battery standby time is less than the Required Battery Standby entered in the Battery Settings section, an alert will be generated. (See Battery Settings, below).

Battery Settings

The Battery Settings block is under the Battery Test block on the power supply page (See next page). The available settings are as follows:

Required Battery Runtime

Enter the required standby time for the application. This number is only used for comparison to the measured standby time after the battery test.

Rated Battery Life

Enter the rated battery life or desired replacement period in years. This is used by the Securitron Netlink to calculate the Battery End-of-Life alert time.



NOTE: The current time and date MUST be set BEFORE setting the rated battery life for proper Battery End-of-Life date calculation..

Rated Capacity

Enter the battery capacity of the battery connected to the AQL. This rating is used by the Securitron Netlink to approximate how much capacity is remaining in the battery (if using the current sensor to monitor battery health).

The screenshot displays the PowerCom Power System Manager interface. At the top, it shows the LifeSafety Power logo and the title "PowerCom POWER SYSTEM MANAGER". The navigation menu includes HOME, Reporting, Configure, and Tools. The user is logged in as "admin" and the version is "8.071-39".

The main content area is divided into several sections:

- Client Information:** Client ID: LifeSafety Power, SITE ID: [Redacted], Date: Fri Aug 10 2018, Time: 11:25:21.
- Device ID:** [Redacted], Ver: 3.4
- Power System Monitoring:** Output Voltage: 13.34 VDC, AC Fault Status: [Green], System Fault Status: [Green], Battery Voltage: 13.26 VDC, Battery Chg Current: -0.00 Amp, FAI Status: [Green], FAI Latch: [Green]. A red "Caution" message states "Battery test in progress. System powered by battery."
- System History:** AC Fault Count: 58, System Fault Count: 137, Battery Installed Time: 12045 Hours, Battery Tests Performed: 0, Battery Tests Failed: 0, System Installed Date: 2016/1/12, Total Power-up Time: 20906 Hours.
- Battery Status Monitoring:** Charge State: [Green], Battery Status: Discharging, Required Standby: 0.00 Hours, Actual Standby: 0.00 Hours, Replace Battery By: 2019/06/06. A "Clear result" button is present.
- Battery Test:** A "Stop Test" button is visible.
- Email Report:** A section for configuring email reports.

Power Supply Settings

The power supply section shows the programmable settings for the Securitron AQL power supply.

The following parameters are available:

Battery Charge Selector

Select the proper battery size range for optimal charging rate.

AC Fault Reporting Delay

Select the desired delay for reporting an AC fault in hours, minutes, and seconds. Note that this delay will affect the AC Fault LED and relay as well as email reporting. Check your local codes regarding fault delays.

System Fault Reporting Delay

Select the desired delay for reporting System fault conditions in hours, minutes, and seconds. Note that this delay will affect the Sys Fault LED and relay as well as email reporting. This setting should be used with caution, as intermittent faults may be masked by a fault delay. System Fault delays should typically be kept to 5 seconds or less to prevent critical faults from being masked. Check your local codes regarding fault delays.

Reset Timer for New Battery Installation

Select this option after installing a new battery set in order to reset the battery replacement alert counter. The Securitron Netlink uses this counter along with the user-entered “Battery Rated Life” to calculate the next battery replacement date. See Battery Settings, previous page.

Enter Installation Date

Enter the date the system was initially installed. This value is only for the user’s information and is not used by the Securitron Netlink.

Reset AC & System Fault Counts

Selecting this option will reset the AC and System Fault counters. This is typically done after testing or servicing the system.

After entering the values or selecting the appropriate options, click the Apply button at the bottom of the “Power Supply Settings” area. These settings will take effect immediately without rebooting the Securitron Netlink

Current Sensor Calibration

The Current Sensor Calibration block is at the bottom of the power supply page. This section allows the current sensor to be calibrated to allow the most accurate current readings.

To perform the calibration

- 1 Ensure the red and orange leads of the current sensor are disconnected and that the white cable on the current sensor is connected to the Securitron Netlink board.
- 2 After the red and orange leads are disconnected, click the Zeroing button. A warning message will appear, reminding you to make sure the current through the sensor is zero (by disconnecting the red and orange leads on the current sensor).
- 3 Click OK, and the Securitron Netlink will self-calibrate to the current sensor.
- 4 Ensure the current reading on the home page is zero (or very close to zero) before reconnecting the current sensor’s red and orange leads. If the reading is not zero, repeat the calibration procedure.

Typical power Supply Page (bottom portion)

The screenshot displays the 'Power Supply Settings' page. It is divided into two main sections: 'Power Supply Settings' and 'Battery Settings'.
Power Supply Settings: This section contains several options, each with a radio button:

- Battery Charge Selector:** A dropdown menu is set to '18 to >60 Ah Battery'.
- AC Fault Reporting Delay In:** Three input fields for Hr, Min, and Sec, all set to 0.
- System Fault Reporting Delay In:** Three input fields for Hr, Min, and Sec, all set to 0.
- Reset Timer for New Battery Installation:** An unchecked radio button.
- Enter Installation Date (mm/dd/yyyy):** Three dropdown menus for month (1), day (12), and year (2016).
- Reset AC and System Fault Counts:** An unchecked radio button.

At the bottom of this section are 'Apply', 'Export', and 'Import' buttons.
Battery Settings: This section has three input fields:

- Required Battery Runtime:** 0:00 Hours
- Rated Battery Life:** 3:0 Years
- Rated Capacity:** 9:0 A-Hr

A 'Submit' button is located to the right of these fields. A small note below the fields states: "Required Battery Runtime" is only used for comparison to the battery test results and does not affect any operation of the NLFPD. Entering battery life and battery capacity ratings allows the software to calculate the battery replacement date and create data for battery SoC meter.
Current Sensor Calibration: This section is at the bottom of the page. It shows 'Sensor Current: 0.63 Amp' and a 'Zeroing' button. Below this is a warning message: 'Make sure there is no current flowing through the current sensor cable before zeroing the current sensor. Zero the sensor current after installation to calibrate sensing circuitry. See manual for proper use of current sensor.'

Using the Tools Page

Clicking the [Tools](#) link at the top of the display will bring up the Tools page. This page allows upgrading of the firmware and rebooting the Securitron Netlink board.

Upgrading Firmware

The Upgrade Firmware section is at the top left of the Tools page. To upgrade the firmware:

- 1 Ensure that the new firmware file is available on your computer, then click the [Upgrade](#) button and the Upgrade window will appear.
- 2 Click the [Browse...](#) button and locate the new firmware file with the file extension “.bin” on your computer.
- 3 Once the file is selected, click the [Download](#) button to temporarily download the new firmware into the RAM of the Securitron Netlink board. This process will take from 30 seconds to 3 minutes depending on network speed and traffic, and the message box will display “Download...”.
- 4 Once the firmware is loaded into the Securitron Netlink’s RAM, it can then be burned to the processor in the Securitron Netlink.
- 5 Verify the correct file name and click the [Confirm](#) button to confirm the upgrade. Next click the [Burn](#) button to begin burning the firmware to the Securitron Netlink’s processor.

NOTE: This process may take up to 12 minutes – DO NOT REMOVE POWER TO THE SECURITRON NETLINK DURING THIS PROCESS or the Securitron Netlink will be rendered nonfunctional.

- 6 Once the update is complete, a message will appear in the message box indicating “Update Finished”.
- 7 The Securitron Netlink must be rebooted in order to start the new firmware.

NOTE: The browser history / cache should be cleared after performing the firmware upgrade and before accessing the Securitron Netlink again to prevent any cached pages from giving outdated information.

Rebooting the Securitron Netlink Board

The “Reboot” section is on the top right of the Tools page. To reboot the Securitron Netlink:

- 1 Click the [Submit](#) button.
- 2 Once the “Confirm Reboot” message appears in the Message window, click the [OK](#) button to Confirm the reboot.
- 3 The rebooting process will take approximately 1-2 minutes, during which time you will lose communication with the Securitron Netlink.
- 4 Communication will be restored once the blue LED lights steady.

NOTE: This section allows the user to enter notes such as service history, installation specifics, reminders, etc. Up to 1000 characters may be entered.

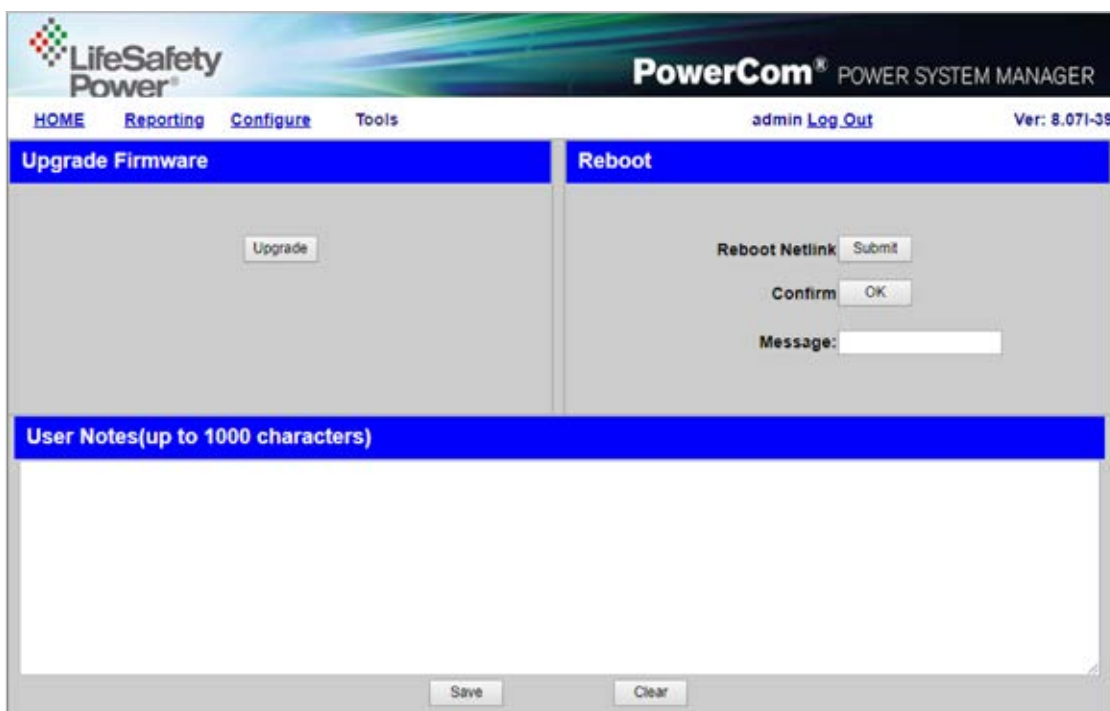

Power Supply Settings

The report file sent by email by the Securitron Netlink is sent as an unformatted .CSV file. Many programs, such as Microsoft Excel, will import a .CSV file to allow viewing of the data. Note that the fields included will vary depending on the specific system and which parameters are selected on the Reporting page.

The example below has been reformatted for better readability in Excel. The top three rows of data give the following basic information:

Site ID

BGO Chicago Office - This is set in the "Site ID" setting on the Configure Page of the Securitron Netlink

Report Trigger

Report Period - this is a periodic status report. The frequency of the status reports is set by the "Send Period" setting in the Email Settings section of the Configure page.

Service Due

No - The "Next Service Due" date set on the Configure page has not been reached.

Below the top three rows is data specific to the Securitron Netlink and any devices connected to it.

Device Name

This column shows which device the associated parameter belongs to. In this example, the devices are the Securitron Netlink and FP1.

Device Parameter

This column shows the available parameters which are being monitored. These parameters vary depending on the device(s) connected to the Securitron Netlink.

Date/Time Stamp

To the right of the Parameter column are columns with date/time stamps. These columns are the data, measured hourly at the dates and times listed. The number of columns displayed is set by the "Select Occurrences to Report" setting on the Reporting page.

Tools page example opened in Excel

	A	B	C	D	E	F	G
1	Site ID	BGO Chicago Office					
2							
3	Report trigger: report period						
4							
5	Service due	no					
6							
7	Device name	Device parameter	Wed Jul 10 2013 09:00:00	Wed Jul 10 2013 08:00:00	Wed Jul 10 2013 07:00:03	Wed Jul 10 2013 06:00:02	Wed Jul 10 2013 05:00:01
8							
9	Netlink	Cabinet internal temperature	87.83 Deg.F	87.83 Deg.F	87.83 Deg.F	94.74 Deg.F	96.46 Deg.F
10							
11	FP1	Model number	AQL	AQL	AQL	AQL	AQL
12							
13	FP1	System fault status	No	No	No	No	No
14							
15	FP1	AC fault status	No	No	No	No	No
16							
17	FP1	FAI status	Active	Active	Active	Active	Active
18							
19	FP1	Output latching on FAI	Inactive	Inactive	Inactive	Inactive	Inactive
20							
21	FP1	Output voltage	12.46 Volts	12.46 Volts	12.46 Volts	12.46 Volts	12.46 Volts
22							
23	FP1	Battery voltage	13.84 Volts	13.81 Volts	13.81 Volts	13.78 Volts	13.81 Volts
24							
25	FP1	Battery charger current	0.00 Amps	-0.00 Amps	-0.00 Amps	-0.00 Amps	-0.00 Amps
26							
27	FP1	Total power-up time	12469 Hours	12468 Hours	12467 Hours	12466 Hours	12465 Hours
28							
29	FP1	Battery installed time	12263 Hours	12262 Hours	12261 Hours	12260 Hours	12259 Hours
30							
31	FP1	# of AC faults detected		133	133	133	133
32							
33	FP1	# of system faults detected		106	106	106	106

Software Agreement

ASSA ABLOY Electronic Security Hardware SOFTWARE LICENSE AGREEMENT AND WARRANTY STATEMENT

NOTICE: PLEASE READ THIS DOCUMENT CAREFULLY. This Software License Agreement (“AGREEMENT”) defines and governs use of ASSA ABLOY Electronic Security Hardware Software and includes WARRANTY DISCLAIMERS. Your acceptance of this AGREEMENT is an acknowledgement, representation and warranty that you have the full right and authority to enter into, execute, and perform obligations under this AGREEMENT, or that you have the authority to enter into and execute this AGREEMENT as an Authorized Representative of a business entity or corporate entity and to bind that business entity or corporate entity to perform obligations under this AGREEMENT by your acceptance, acknowledgment and representation.

TERMS AND CONDITIONS

1. DEFINITIONS.

- **“Authorized Representative”** refers to any person duly authorized by a business entity or corporate entity (i.e. a “legal entity”) to enter into this AGREEMENT and to bind the legal entity to the terms and conditions herein.
- **“Recipient”** refers to any individual or legal entity, entering into and executing this AGREEMENT for purposes of use of ASSA ABLOY Electronic Security Hardware Software, where “use” is as defined by this AGREEMENT.
- **“Documentation”** refers to any related explanatory written materials or files including, without limitation, any end-user manual, specifications or other written materials provided to Recipient for the Software.
- **“Facility”** refers to any facility where ASSA ABLOY Electronic Security Hardware Equipment is located and/or where the Software is installed or used under control of Recipient in conjunction with such Equipment.
- **“Software”** refers to all the contents of files provided to Recipient by electronic download, on physical media (including EEPROM or ROM chips etc.) and/or any other method of distribution, disk(s), CD-ROM(s), DVD-ROM(s), or other media with which this AGREEMENT is provided, including, without limitation, fonts, graphics, user-interfaces, Upgrades, updates, additions to, and any copies of the foregoing, provided to Recipient by ASSA ABLOY Electronic Security Hardware
- **“Upgrades”** refers to new versions, updates, and revisions of the Software provided to Recipient by ASSA ABLOY Electronic Security Hardware
- **“Use”** refers to actions taken exclusively by Recipient to copy for backup purposes, download, install, access, and to enjoy and benefit from features and functionality of the Software, subject to all restrictions set forth in this Agreement.

2. LICENSE AND RESTRICTIONS.

- **Grant of Rights.** ASSA ABLOY Electronic Security Hardware hereby grants Recipient a non-exclusive license to have one (1) copy of the Software in Recipient’s possession and control at one (1) facility of Recipient. Recipient may install the Software and may access the Software by concurrent users over a network connection in accordance with the Documentation. Recipient may also make one (1) additional copy for backup or archival purposes at one (1) Recipient facility which may be a different Recipient facility from where the other Software copy is installed and used. Recipient may also Upgrade the Software subject to Upgrades that may be provided from time-to-time by ASSA ABLOY Electronic Security Hardware at its sole discretion. The Software, subsequent to any Upgrade, shall be subject to the same terms, conditions and restrictions as provided herein, and shall also be subject to any other applicable modifications or amendments to this AGREEMENT that may accompany the Upgrade as provided for herein. Recipient shall comply with all restrictions set forth in this AGREEMENT.
- **Reservation of Rights.** Copies of the Software created or transferred pursuant to this Agreement are licensed, not sold, and Recipient receives no title to, or ownership of, any copy or of the Software itself. The Software is protected by copyright laws, and by international treaty provisions, and includes trade secrets of ASSA ABLOY Electronic Security Hardware, and Recipient shall not disclose it to any third party except to the extent required

by law. Furthermore, Recipient receives no intellectual property rights or any other rights to the Software other than those specifically granted in Section 2(a). Any rights not expressly granted in Section 2(a) are reserved by ASSA ABLOY Electronic Security Hardware

- **Restrictions.** Without limiting the generality of the foregoing, Recipient shall not: (i) modify, create derivative works from, distribute, publicly display, publicly perform, or sublicense the Software; (ii) use the Software for service bureau or time-sharing purposes or in any other way allow third parties to exploit the Software; or (iii) reverse engineer, decompile, disassemble, or otherwise attempt to derive any of the Software’s source code.
- **No Distribution, No Modification, No Derivative Works.** Recipient shall not network, rent, lend, loan, distribute or create derivative works based upon the Software in whole or in part; or electronically transmit the Software from one computer to another or over a network. Recipient shall not modify, adapt, translate or create derivative works based upon the Software.
- **No Reverse Engineering.** Recipient shall not engage in, or induce a third party to engage in, reverse engineering of the Software. “Reverse Engineering” means i) the disassembly, decompilation, decryption, simulation, debugging or code tracing of microcode; and/or ii) the disassembly, decompilation, decryption, simulation, debugging or coded tracing of object code or executable code, specifically including, but not limited to, any ASSA ABLOY Electronic Security Hardware supplied or developed libraries or microcode. Regarding any of ASSA ABLOY Electronic Security Hardware’s software and/or firmware “Reverse Engineering” shall also mean iii) the act of producing computer program “source code” that, when compiled, will generate computer programs that provide the same, or similar functions as the Software, by means of translating the object code, which may be provided by ASSA ABLOY Electronic Security Hardware under this Agreement, (including object code in ROM memory chips as well as object code provided on computer-readable magnetic media or object code provided by downloading, from the computer binary instructions into equivalent programming language instructions, in assembly language or other computer programming language). This term is also intended to include the development of software that incorporates the methods, techniques, styles and approaches of the Software, while performing similar functions.
- **No Exportation.** Recipient shall not ship, transfer or export the Software into any country or use the Software in any manner prohibited by the United States Export Administration Act or any other export laws, restrictions or regulations (collectively the “Export Laws”). In addition, if the Software is identified as export controlled items under the Export Laws, you represent and warrant that you are not a citizen, or otherwise located within, an embargoed nation (including without limitation Iran, Syria, Sudan, Cuba, and North Korea) and that you are not otherwise prohibited under the Export Laws from receiving the Software. All rights to use the Software are granted on condition that such rights are forfeited if you fail to comply with the terms of this agreement.
- **Assignment & Successors.** The rights and obligations under this AGREEMENT may not be assigned, without the express prior written consent of all the Parties, provided, however, consent to assignment of the rights and obligations hereunder as part of the sale of a Recipient’s entire business relevant to this AGREEMENT shall not be required. Furthermore, either party may assign this AGREEMENT to the surviving party in a merger of that party into another entity. Except to the extent forbidden above, this AGREEMENT will be binding upon and inure to the benefit of the respective successors and assigns of the parties.
- **Third Party Interoperability.** The Software may interoperate with and allow you to use software applications, information and data not developed or offered by ASSA ABLOY Electronic Security Hardware (“Third Party Information”). Your use of any Third Party Information is governed by the terms and conditions made available to you by the party from whom you obtained such information. Unless otherwise agreed by ASSA ABLOY Electronic Security Hardware in writing, Third Party Information is not the responsibility of ASSA ABLOY Electronic Security Hardware YOUR USE OF THIRD PARTY INFORMATION IS AT YOUR OWN RISK. ASSA ABLOY

Electronic Security Hardware MAKES NO WARRANTIES, CONDITIONS, INDEMNITIES, REPRESENTATIONS OR TERMS, EXPRESS OR IMPLIED, WHETHER BY STATUTE, COMMON LAW, CUSTOM, USAGE OR OTHERWISE AS TO ANY MATTERS, INCLUDING BUT NOT LIMITED TO NON-INFRINGEMENT OF THIRD PARTY RIGHTS, TITLE, INTEGRATION, INTEROPERABILITY, ACCURACY, SECURITY, AVAILABILITY, SATISFACTORY QUALITY, MERCHANTABILITY OR FITNESS FOR ANY PARTICULAR PURPOSE WITH RESPECT TO THIRD PARTY INFORMATION.

- **Notices.** Recipient shall not remove or alter any copyright, trademark or other proprietary notice that appears on or in the Software.
 - **Software License Compliance Audit.** ASSA ABLOY Electronic Security Hardware may audit Recipient’s use of the Software on thirty (30) days’ advanced written notice. Recipient agrees to cooperate with the audit, including by providing access to any books, computers, records, or other information that relate or may relate to use of the Software. Such audit will not unreasonably interfere with Recipient’s business activities. In the event that an audit reveals unauthorized use of the Software, Recipient shall reimburse ASSA ABLOY Electronic Security Hardware for the reasonable cost of the audit, in addition to such other rights and remedies as ASSA ABLOY Electronic Security Hardware may have. ASSA ABLOY Electronic Security Hardware will not conduct an audit more than once per year.
 - **Trademarks.** No rights whatsoever to use any trademarks, registered or unregistered, are granted by any provision of this AGREEMENT.
- #### 3. UPGRADES.
- **Upgrades.** ASSA ABLOY Electronic Security Hardware may provide Recipient with copies of Upgrades without additional charge, from time-to-time. Upon delivery to Recipient, Upgrades will become part of the Software and will be subject to all provisions of this AGREEMENT.
 - **Upgrades and Software License Agreement Terms.** ASSA ABLOY Electronic Security Hardware may require additional terms that are additional to this AGREEMENT or that modify or amend this AGREEMENT upon Recipient’s installation and use of Upgrades. Any such additional terms, modified or amended terms will require Recipient’s execution of a new Agreement which will subsequently replace and supersede this AGREEMENT. Recipient may reject such additional terms, modified or amended terms by not downloading or installing the associated Upgrade(s).
 - **Reservations regarding Upgrades.** ASSA ABLOY Electronic Security Hardware may cease providing Upgrades at any time and/or may cease providing Upgrades without additional charge and may require an additional charge for Upgrades at any point in time without notice. Recipient will be informed of any such additional charges at the time of requesting such Upgrades. Upgrades may be requested by downloading or by requesting other forms of delivery.
- #### 4. DISCLAIMER OF WARRANTIES.
- **“AS-IS” SOFTWARE.** THE SOFTWARE (AS DEFINED IN THIS AGREEMENT) IS PROVIDED ON AN “AS IS”, “AS AVAILABLE” BASIS AND WITH ALL FAULTS.
 - **WARRANTY DISCLAIMERS, NO WARRANTY.** ASSA ABLOY Electronic Security Hardware MAKES NO WARRANTIES, EITHER EXPRESS OR IMPLIED, WHETHER BY STATUTE, COMMON LAW, CUSTOM, USAGE OR OTHERWISE, INCLUDING WITHOUT LIMITATION ANY IMPLIED WARRANTIES OF MERCHANTABILITY OR FITNESS FOR A PARTICULAR PURPOSE. ASSA ABLOY Electronic Security Hardware MAKES NO WARRANTIES, CONDITIONS, REPRESENTATIONS, OR TERMS (EXPRESS OR IMPLIED WHETHER BY STATUTE, COMMON LAW, CUSTOM, USAGE OR OTHERWISE) AS TO ANY MATTER INCLUDING WITHOUT LIMITATION PERFORMANCE, RESULTS, NON-INFRINGEMENT OF ANY PARTY’S RIGHTS, MERCHANTABILITY, INTEGRATION, SATISFACTORY QUALITY, OR FITNESS FOR ANY PARTICULAR PURPOSE.
 - ASSA ABLOY Electronic Security Hardware POWER PROVIDES NO TECHNICAL SUPPORT OR REMEDIES FOR THE SOFTWARE.
 - ASSA ABLOY Electronic Security Hardware does not warrant that the Software will perform without error or that it will run without immaterial interruption. ASSA ABLOY Electronic Security Hardware provides

no warranty regarding, and will have no responsibility for, any claim arising out of: (i) a modification of the Software; or (ii) use of the Software in combination with any operating system or Third Party Information not authorized in the Documentation or with hardware or software specifically forbidden by the Documentation.

5. LIMITATION OF LIABILITY.

- **Limitations.** Except as provided below: (i) IN NO EVENT WILL ASSA ABLOY Electronic Security Hardware'S, OR ANY OF ITS OFFICERS', DIRECTORS', SHAREHOLDERS', PARENTS', SUBSIDIARIES', AGENTS', INSURERS', SUCCESSORS', AND/OR ASSIGNS', LIABILITY ARISING OUT OF OR RELATED TO THIS AGREEMENT EXCEED THE AGGREGATE OF FEES PAYABLE TO ASSA ABLOY Electronic Security Hardware PURSUANT TO THIS AGREEMENT (INCLUDING FEES BOTH PAID AND DUE) AT THE TIME OF THE EVENT GIVING RISE TO THE LIABILITY; AND (ii) IN NO EVENT WILL ASSA ABLOY Electronic Security Hardware OR ANY OF ITS OFFICERS, DIRECTORS, SHAREHOLDERS, PARENTS, SUBSIDIARIES, AGENTS, INSURERS, SUCCESSORS, AND/OR ASSIGNS BE LIABLE FOR ANY CONSEQUENTIAL, INDIRECT, SPECIAL, INCIDENTAL, OR PUNITIVE DAMAGES. THE LIABILITIES LIMITED BY THIS SUBSECTION 5(a) APPLY: (A) TO LIABILITY FOR NEGLIGENCE; (B) REGARDLESS OF THE FORM OF ACTION, WHETHER IN CONTRACT, TORT, STRICT PRODUCT LIABILITY, OR OTHERWISE; (C) EVEN IF ASSA ABLOY Electronic Security Hardware, AND/OR ANY OF ITS OFFICERS, DIRECTORS, SHAREHOLDERS, PARENTS, SUBSIDIARIES, AGENTS, INSURERS, SUCCESSORS, AND/OR ASSIGNS IS/ ARE ADVISED IN ADVANCE OF THE POSSIBILITY OF THE DAMAGES IN QUESTION AND EVEN IF SUCH DAMAGES WERE FORESEEABLE; AND (D) EVEN IF RECIPIENT'S REMEDIES FAIL OF THEIR ESSENTIAL PURPOSE. If applicable law limits the application of the provisions of this Section 5(a), ASSA ABLOY Electronic Security Hardware's liability will be limited to the maximum extent permissible.
- **Further Limitations.** IN NO EVENT WILL ASSA ABLOY Electronic Security Hardware OR ANY OF ITS OFFICERS, DIRECTORS, SHAREHOLDERS, PARENTS, SUBSIDIARIES, AGENTS, INSURERS, SUCCESSORS, AND/OR ASSIGNS BE LIABLE FOR ANY CONSEQUENTIAL, INDIRECT, SPECIAL, INCIDENTAL, OR PUNITIVE DAMAGES ARISING OUT OF OR RELATED TO ANY OF THE FOLLOWING:
 - › Revisions to the Software made without the express, written consent of ASSA ABLOY Electronic Security Hardware; Recipient's failure to incorporate Software Upgrades that would have avoided the alleged liability, provided ASSA ABLOY Electronic Security Hardware offered such Upgrades without fees or charges and with notice to Recipient thereof; use of the Software in combination with hardware or software or Third Party Information not provided by ASSA ABLOY Electronic Security Hardware: (A) that is specifically forbidden by the Documentation; or (B) that is not designated in the Documentation as available for interface with the Software.

6. Term and Termination.

- **Term.** This AGREEMENT shall remain in effect so long as the Recipient continues to use and/or maintain any copies of the Software within Recipient's possession or control in any storage medium without limitation.
- **Termination for Cause.** Either party may terminate this AGREEMENT for material breach by written notice, effective in 30 days unless the other party first cures such breach. (Effects of Termination. Upon termination of this AGREEMENT, the licenses granted herein shall terminate and Recipient shall cease all use of the Software and delete all copies in its possession or control. The following provisions will survive termination of this AGREEMENT: (i) any obligation of Recipient to pay for Software and/or Upgrades rendered before termination; (ii) Sections 4, 5 and 7 of this AGREEMENT; and (iii) any other provision of this AGREEMENT that must survive termination to fulfill its essential purpose.

7. Miscellaneous.

- **Notice and Contact Information.** ASSA ABLOY Electronic Security Hardware may be contacted at the mailing address below or by the ASSA ABLOY Electronic Security Hardware website. Notices pursuant to this AGREEMENT should be sent to the address below, or to such others as may be provided in writing. Such notices will be deemed received at such addresses upon the earlier of (i) actual receipt or (ii) delivery in person, by fax with written confirmation of receipt, or by certified mail return receipt requested.
- **Corporate Headquarters,** Mailing Address: ASSA ABLOY Electronic Security Hardware, 10027 S. 51st Street Phoenix, AZ 85044, USA
- **Website** Address: www.assaabloyesh.com
- **Independent Contractors.** The parties are independent contractors and will so represent themselves in all regards. Neither party is the agent of the other and neither may bind the other in any way. Nothing in this AGREEMENT is intended or shall be construed to create between the Parties a relationship of principal and agent, partners, joint venturers, or employer and employee. No Party shall hold itself out to others or seek to bind or commit another Party in any manner inconsistent with this AGREEMENT.
- **No Waiver.** Neither party will be deemed to have waived any of its rights under this AGREEMENT by lapse of time or by any statement or representation other than (i) by an Authorized Representative and (ii) in an explicit written waiver. No waiver of a breach of this AGREEMENT will constitute a waiver of any prior or subsequent breach of this AGREEMENT.
- **Force Majeure.** To the extent caused by force majeure, no delay, failure, or default will constitute a breach of this AGREEMENT.
- **Choice of Law & Jurisdiction.** This AGREEMENT shall be governed solely by the internal laws of the State of Arizona, without reference to such State's principles of conflicts of law. The parties consent to the personal and exclusive jurisdiction of the federal and state courts of Illinois, United States of America.
- **Severability.** All of the provisions of this AGREEMENT are intended to be distinct and severable. To the extent permitted by applicable law, the parties hereby waive any provision of law that would render any clause of this AGREEMENT invalid or otherwise unenforceable in any respect. In the event that a provision of this AGREEMENT is held to be invalid or otherwise unenforceable, such provision will be interpreted to fulfill its intended purpose to the maximum extent permitted by applicable law, and the remaining provisions of this AGREEMENT will continue in full force and effect.
- **Conflicts among Attachments.** In the event of any conflict between the terms of this main body of this AGREEMENT and those of any attachment including those of any documentation, the terms of this main body will govern.
- **Electronic Execution, Binding Agreement.** This AGREEMENT may be executed as a "click-wrap" or "browse-wrap" AGREEMENT or by other form of electronic signature and Recipient agrees that this execution shall result in a binding AGREEMENT between the parties. RECIPIENT AGREES THAT THIS AGREEMENT IS ENFORCEABLE LIKE ANY WRITTEN NEGOTIATED AGREEMENT SIGNED BY RECIPIENT OR RECIPIENT'S AUTHORIZED REPRESENTATIVE. THIS AGREEMENT IS ENFORCEABLE AGAINST RECIPIENT AND ANY LEGAL ENTITY THAT OBTAINED THE SOFTWARE AND ON WHOSE BEHALF IT IS USED. IF YOU DO NOT AGREE, DO NOT INSTALL OR USE THIS SOFTWARE.
- **Interpretation and Construction.** The parties agree that the terms of this AGREEMENT result from negotiations between them. This AGREEMENT will not be construed in favor of or against either party by reason of authorship.

- **Entire Agreement.** This AGREEMENT sets forth the entire AGREEMENT of the parties and supersedes all prior or contemporaneous writings, negotiations, and discussions with respect to the subject matter hereof. Neither party has relied upon any such prior or contemporaneous communications.
- **Modification or Amendment.** Notwithstanding any modifications related to Upgrades made in accordance with section 3(b) above, this AGREEMENT may not be modified or amended except (i) by Authorized Representatives of each party and (ii) in a written contract signed by both parties.
- **Headings.** The headings of sections and subsections have been included for convenience only and shall not be considered in interpreting this AGREEMENT.
- **Counterparts.** This AGREEMENT may be executed in one or more counterparts, each of which shall be deemed to be an original, and all of which together shall constitute one and the same AGREEMENT.
- **Notice to U.S. Government End Users.** The development of the Software has been exclusively at the private expense of ASSA ABLOY Electronic Security Hardware. Accordingly, the Software and Documentation are "Commercial Items," as that term is defined at 48 C.F.R. §2.101, and comprises "Commercial Computer Software" and "Commercial Computer Software Documentation," as such terms are used in 48 C.F.R. §12.212 or 48 C.F.R. §227.7202, as applicable. Accordingly, and consistent with 48 C.F.R. §12.212 or 48 C.F.R. §§227.7202-1 through 227.7202-4, as applicable, the Commercial Computer Software and Commercial Computer Software Documentation are being licensed to U.S. Government end users (a) only as Commercial Items and (b) with only those rights as are granted to all other end users pursuant to the terms and conditions herein.